

KATALOG 2012

CATALOGUE 2012



 **skymaster**[®]

SKYMASTER. WE CONNECT YOU.



SM ELECTRONIC – fit für den Markt der Zukunft

Seit über 30 Jahren ist SM ELECTRONIC erfolgreich im Segment der Empfangstechnologie und des elektronischen Zubehörs tätig. Durch unsere Erfahrung und Kompetenz haben wir uns im deutschen Markt gut positioniert. Unsere stabile Preispolitik und hoher Qualitätsanspruch ließen uns in den letzten Jahren zu einem der Marktführer unserer Branche aufsteigen.

Unsere Kunden

Unser Kundenkreis reicht von Fachmärkten über Warenhäuser und SB-Märkten bis hin zu Handelsketten und wächst stetig an. In der deutschen Handelslandschaft gibt es nahezu keine Präsenzlücken.

Gute Beratung

Wenn Sie Unterstützung in der Verkaufsförderung benötigen, werden Sie bei uns in allen Bereichen bis ins Detail beraten. Unser Team steht für Sie zur Verfügung und freut sich darauf, Ihnen mit kompletten Konzeptlösungen zur Seite zu stehen.

Produktverpackungen

Der Grundgedanke unseres Verpackungskonzeptes ist die vollständige SB-Fähigkeit. Diese wird durch eine eindeutige Produktbeschreibung erreicht. So kann sich der Kunde schnell und umfassend über die Produkte informieren.

Sortimentspflege

Für Sie entwickeln wir ein auf Ihre Belange abgestimmtes Konzept. Unsere Mitarbeiter sorgen anschließend für die reibungslose Durchführung. Durch geschulte Marktbetreuer ist u.a. gewährleistet, daß immer die aktuellsten Produkte in Ihrem Sortiment präsentiert sind.

Unter der Telefon-Nummer **+49 (0)40-675 09-0** oder unserer E-Mail Adresse **info@sm-electronic.de** stehen wir Ihnen gerne persönlich zur Verfügung. Im Internet finden Sie uns unter **www.sm-electronic.de** oder **www.skymaster.de**.

Wir freuen uns auf Sie.

SM ELECTRONIC GmbH ist ein Unternehmen der **GIGASET AG**.

SM ELECTRONIC – Fit for the Market of the Future

SM ELECTRONIC has been working successfully in the sectors of reception technology and electronic accessories for more than 30 years. Due to our experience and expertise we have been able to achieve an excellent position in the German market. Our stable price policy and high quality standards have enabled us to become a market leader in our sectors in recent years.

Our customers

Our customers range from specialist shops and department stores to cash and carry stores and trade chains and their number is growing continuously. In the domestic market there is nearly no lack of presence.

Expert advice

If you require help with sales promotions we can offer you detailed advice in each and every area. Our team is always at your disposal and looks forward to helping you with complete concept solutions.

Product packaging

The fundamental idea behind our packaging concept is the complete self-service capability. Clear product descriptions explain any important information support this idea. This allows the customer to receive quick and extensive information about the product.

Caring for the range of products

We develop an individual concept for your needs and our employees ensure its subsequent problem-free implementation. Due to skilled store advisers, we are, amongst other things, able to guarantee that current products are always available in your range of goods.

Please contact us on **+49 (0)40-675 09-0** or via e-mail **info@sm-electronic.de**. Also visit our website at **www.sm-electronic.de** or **www.skymaster.de**.

We are looking forward hearing from you.

SM ELECTRONIC GmbH is a company of **GIGASET AG**.

Art.-Nr.	Seite	item-no.	Page										
2318	73	3204	30	3549	46	3827	13	7208	61	23157	27	35333	60
2398	73	3207	29	3553	47	3828	13	7209	61	23163	27	35402	64
2422	67	3209	48	3554	46	3835	13	7210	61	23165	27	35403	64
2430	67	3210	28	3555	46	3836	13	7211	61	23202	29	35404	64
2431	66	3213	48	3558	47	3837	13	7218	62	23245	32	35405	64
2432	66	3214	28	3559	47	3846	42	7219	62	23290	52	35406	64
2433	66	3216	28	3561	65	3847	42	7228	61	23500	18	35410	65
2435	67	3223	25	3562	58	3851	15	7229	61	23501	18	35412	64
2436	67	3227	47	3564	43	3862	63	7252	37	23502	18	35461	42
2463	53	3240	20	3565	43	3863	63	7253	37	23503	18	35465	42
2501	26	3246	52	3566	44	3864	63	7263	38	23504	18	36002	7
2505	31	3247	52	3567	43	3865	63	7265	37	23505	18	36003	8
2508	31	3249	48	3570	58	3880	42	7266	37	23506	18	37041	14
2523	26	3251	48	3571	43	3881	42	7291	35	23507	18	37173	10
2531	26	3267	21	3572	43	3920	17	7300	56	23508	18	37351	10
2557	53	3271	20	3573	43	3921	17	7301	56	23509	18	37355	10
2558	52	3274	20	3580	59	3922	17	7305	54	23510	13	37511	15
2601	31	3276	49	3584	42	3923	17	7306	55	23511	18	37512	15
2630	25	3280	21	3586	45	7007	35	7359	74	23526	47	37519	16
2702	72	3281	25	3587	45	7008	35	7360	74	23546	42	37520	16
2710	72	3283	20	3595	17	7013	35	7390	65	23547	42	37601	9
2719	72	3299	49	3596	17	7014	35	7392	39	23554	46	37602	9
2720	68	3303	53	3597	65	7016	35	7400	73	23555	46	37604	9
2722	68	3311	46	3603	8	7027	37	7451	56	23584	42	37605	9
2724	72	3312	46	3608	7	7030	36	7471	39	23699	12	37621	9
2732	70	3313	46	3609	7	7031	36	7472	39	23705	12	37622	9
2735	71	3321	51	3613	45	7036	38	7473	39	23706	12	37624	9
2736	71	3334	17	3620	59	7043	54	8014	34	23707	12	37625	9
2742	68	3335	17	3622	59	7046	37	8113	34	23770	13	38281	13
2744	69	3336	17	3646	42	7057	37	8120	49	23771	13	38291	13
2745	69	3337	17	3654	45	7068	37	8121	22	23772	13	38351	13
2748	70	3380	50	3655	45	7081	36	8122	22	23773	13	38361	13
2820	29	3381	50	3659	45	7086	54	8124	23	25036	26	38371	13
2828	31	3383	50	3666	44	7087	54	8126	33	25052	21	39151	12
2898	27	3384	51	3667	8	7088	36	8128	33	25054	21	39152	12
2955	28	3395	51	3676	14	7091	37	8144	29	25055	21	39161	12
2961	20	3396	51	3680	42	7092	37	8221	33	25059	21	39162	12
2963	20	3397	51	3681	43	7096	38	8223	33	25071	26	39171	12
2965	20	3444	40	3682	42	7110	55	8224	33	25073	26	39172	12
2966	32	3500	18	3683	44	7111	55	8225	33	25075	26	39321	10
2968	25	3501	18	3684	44	7112	55	8263	23	25262	49	39600	74
3041	29	3502	18	3687	43	7132	37	8281	49	27046	37	81101	34
3100	40	3504	18	3696	14	7134	54	8284	49	27070	38	81151	34
3104	50	3505	18	3697	14	7135	55	8411	40	27072	38	81161	23
3109	30	3506	18	3698	14	7136	55	8508	53	27081	36	81171	24
3110	28	3507	18	3704	14	7145	54	8509	53	27088	36	81174	24
3111	50	3508	18	3713	10	7156	33	8510	33	27208	61	81175	24
3112	50	3509	18	3720	14	7157	33	8511	33	27209	61	81179	22
3118	29	3510	13	3732	58	7162	38	8512	33	27301	68	81180	22
3124	50	3514	47	3733	60	7163	38	8513	33	28272	22	81251	23
3131	26	3516	13	3746	63	7164	38	8514	33	28273	22	81252	23
3138	29	3518	19	3747	58	7165	38	8522	33	28290	23	81515	20
3140	50	3519	19	3751	15	7171	35	8789	74	28291	23	81516	20
3141	29	3522	60	3753	60	7176	35	13581	59	28292	23	85914	24
3142	51	3526	47	3760	63	7183	36	14840	6	28297	22		
3143	29	3527	47	3761	63	7184	36	14860	6	33505	18		
3147	51	3528	17	3764	63	7186	36	14880	6	33506	18		
3152	27	3532	17	3805	12	7187	36	22952	32	33507	18		
3165	27	3533	60	3806	12	7191	35	22953	32	33508	18		
3167	27	3543	65	3807	12	7192	35	22956	32	33509	18		
3168	29	3546	42	3808	12	7193	35	23139	29	33704	19		
3202	29	3547	42	3814	12	7199	62	23152	27	35050	18		
3203	29	3548	46	3815	12	7205	62	23155	27	35332	60		

SAT

- SAT-Spiegel
- DVB-T Antennen
- LNB
- SAT-Komponenten

Kabel

- F-Kabel
- Antennen-Kabel
- HDMI-Kabel
- USB-Kabel
- Scart-Kabel
- Cinch-Kabel
- Klinke-Kabel
- Lichtleiter-Kabel
- S-VHS-Kabel
- YUV-Kabel
- Lautsprecher-Kabel
- Netzwerk-Kabel
- Monitor-Kabel
- Telefon-Kabel
- Netzkabel und Kabel-Sets
- Netzteile

Stecker

- F-Stecker
- Antenne
- HDMI/DVI
- USB
- Cinch/Klinke
- Scart
- Video
- Netzwerk
- Lautsprecher
- Telefon

Zubehör

- Verstärker / Verteiler
- Dosen
- Montage
- Fernbedienungen
- Wandhalter
- Kopfhörer
- Akkus
- Reinigung
- Sonstiges

SAT 5

- Dish 6
- DVB-T Antenna 7
- LNB 9
- SAT components 10

Cable 11

- F cable 12
- Antenna cable 17
- HDMI cable 20
- USB cable 22
- Scart cable 25
- Cinch cable 27
- Jack cable 29
- Optical fibre cable 31
- S-VHS cable 31
- YUV cable 32
- Loudspeaker cable 32
- Network cable 33
- Monitor cable 34
- Telephone cable 35
- Power cable and cable sets 40
- Mains unit 40

Plug 41

- F plug 42
- Antenna 45
- HDMI/DVI 48
- USB 49
- Phono/Jack 50
- Scart 52
- Video 52
- Network 53
- Loudspeaker 53
- Telephone 54

Accessories 57

- Amplifier / Distributor 58
- Socket 60
- Mounting 63
- Remote control 66
- Brackets 68
- Earphone 73
- Battery 74
- Cleaning 74
- Others 74



SAT-Spiegel	Dish	6
DVB-T Antennen	DVB-T Antenna	7
LNB	LNB	9
SAT-Komponenten	SAT components	10



SAT-Spiegel

SAT dish

Satelliten Antenne

Qualitätsmetallspiegel

- Hochwertiger Spiegel zum optimalen Empfang auch schwacher Sender
- Wetterbeständiger, langlebiger Metallspiegel
- Korrosionsgeschütztes Montageset
- Rostfreier LNB-Arm
- LNB-Befestigung durch wetterbeständige Kunststoffhalterung
- Montageset
- Montage-/Bedienungsanleitung

Erweiterbar auch zur Multifeed-Empfangsanlage durch passenden Multifeed-Halter (Artikel 3713)

Satellite dish

high quality steel dish

- High quality dish for optimum reception even of weak stations
- Weather-resistant, long-life metal dish
- Corrosion-protected fitting kit
- Rust-free LNB arm
- LNB fixing by means of weather-resistant plastic brackets
- Fitting kit
- Fitting/operating instructions

Can also be expanded to form a multifeed receiver system by means of suitable multifeed brackets (item 3713).

EAN	Art.-Nr. item-no.	Ø	DIY	VPE QTY
4000953	14840 4	40cm	-	5
4000953	14860 2	60cm	-	5
4000953	14880 0	80cm	-	2



DVB-T Antennen

DVB-T antennas

Universal-Zimmerantenne (36002)

für DVB-T- und TV-/Radio-Empfang

- Verstärkung: 30dB, einstellbar
- Spannungsversorgung: 230V/50Hz oder 12V DC

Universal indoor antenna (36002)

for DVB-T & TV/radio reception

- Amplification: 30 dB, adjustable
- Power supply: 230V/50Hz or 12V DC

Aktive DVB-T Designantennen (3609/3608)

für DVB-T- & TV-/Radio-Empfang

- Frequenzbereiche VHF, UHF und FM
- Einstellbare Verstärkung (3609: 39dB • 3608: 44dB)
- Kleine und kompakte Bauform
- Spannungsversorgung über 230V Wechselspannung oder 12 V Gleichspannung (Kfz)

Active DVB-T Design Antennas (3609/3608)

for DVB-T & TV/radio reception

- Frequency ranges VHF, UHF and FM
- Settable gain (3609: 39dB • 3608: 44dB)
- Small and compact design
- Power supply via 230V AC or 12 V DC (car)

EAN	Art.-Nr. item-no.	Farbe colour	DIY	VPE QTY
4000953	36002 8	schwarz	-	12
40009530	3609 1	schwarz	-	10
40009530	3608 4	silber	-	10



DVB-T Antennen

DVB-T Antenna

DVB-T Stabantenne (3603)

- Antennengewinn 3dB
- Für UHF und VHF einsetzbar

Aktive DVB-T Stabantenne (3667)

- Antennengewinn 22dB
- Für UHF und VHF einsetzbar
- Stromversorgung vom Receiver: 5V/50mA

Aktive DVB-T Stabantenne mit Öko-Netzteil (36003)

- Antennengewinn 22dB
- Für UHF und VHF einsetzbar
- Stromversorgung: 5V/50mA

DVB-T Rod Antenna (3603)

- gain 3dB
- UHF/VHF-capable

Active DVB-T rod antenna (3667)

- gain 22dB
- UHF/VHF-capable
- Power supply by receiver: 5V/50mA

Active DVB-T rod antenna with eco mains unit (36003)

- gain 22dB
- UHF/VHF-capable
- Power supply: 5V/50mA

EAN	Art.-Nr. item-no.	Kabellänge cable length	DIY	VPE QTY
40009530	3603 9	1,5m	-	6
40009530	3667 1	2,0m	-	6
4000953	36003 5	2,0m	-	3

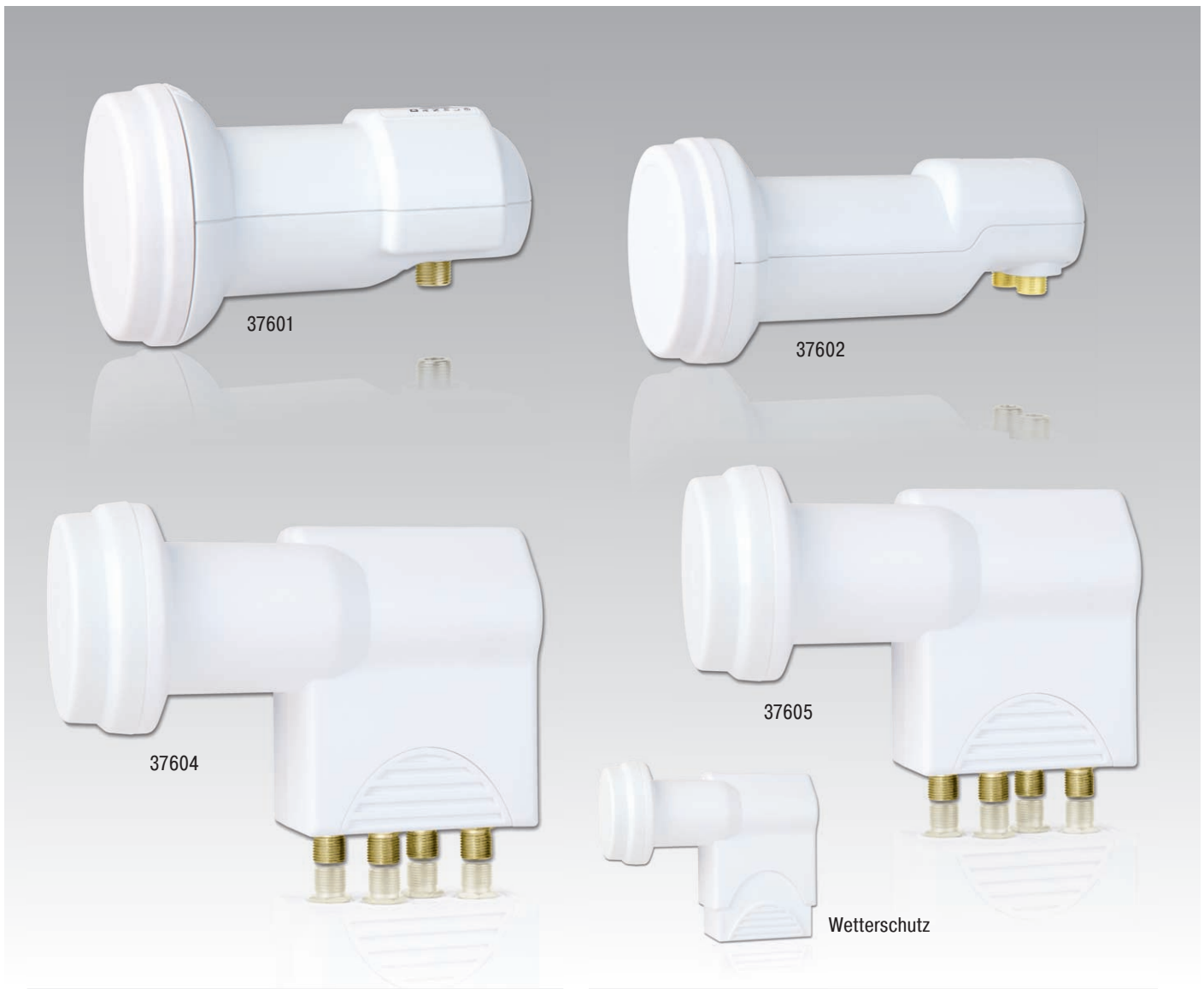

LNB White Line

LNB White Line

Digital LNB

- Perfekte Bilder mit brillanter Bildschärfe durch neuartige, rauscharme Empfangstechnologie (0,2 dB)
- Optimierte Umschaltechnik ermöglicht schnelleres Zapping
- Geeignet für alle LNB-Befestigungen mit Ø 40 mm
- Vergoldete F-Buchsen (37601, 37602, 37604, 37605)
- Minimale Bauform mit integriertem Wetterschutz!

Digital Single-LNB

Empfohlen für den Empfang digitaler und analoger Satellitenprogramme

Digital Twin-LNB

Ermöglicht den Aufbau einer Zweiteilnehmer-Satellitenanlage

Digital Quad-LNB

Ermöglicht den Aufbau einer Mehrteilnehmer-Satellitenanlage (max. 4 Teiln.)

Digital Quattro-LNB

Ermöglicht den Aufbau einer Mehrteilnehmer-Satellitenanlage. Bei Verwendung eines entsprechenden Multischalters können 4/ 8 /16 Teilnehmer angeschlossen werden.

Digital LNB

- Perfect images with brilliant definition thanks to new low-noise receiving technology (0.2 dB)
- Optimised switching technology enables quicker zapping
- Suitable for all LNB mountings with Ø 40mm
- Gold plated F jacks (37601, 37602, 37604, 37605)
- Minimum size with integrated weather protection!

Digital Single-LNB

Recommended for receiving digital and analog satellite programs

Digital Twin-LNB

Enables configuration of a twin-subscriber satellite system

Digital Quad-LNB

Enables configuration of a multiple-subscriber satellite system (max. 4 subscribers)

Digital Quattro-LNB

Enables configuration of a multiple-subscriber satellite system. 4/8/16 subscribers can be connected with use of an appropriate multi-switch.

EAN	Art.-Nr. item-no.	VPE QTY
4000953	37601 2	Single 20
4000953	37602 9	Twin 25
4000953	37604 3	Quad 15
4000953	37605 0	Quattro 15
4000953	37621 0	Single · Aktion 50
4000953	37622 7	Twin · Aktion 50
4000953	37624 1	Quad · Aktion 30
4000953	37625 8	Quattro · Aktion 30

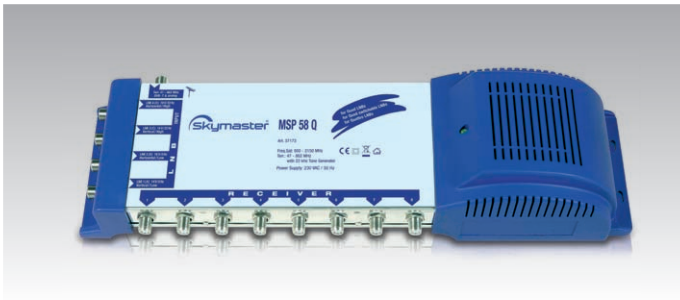

Multi-switch MSP 58 Q

Hochwertiger, digitaltauglicher Multischalter inklusive terrestrischem Antenneneingang. Anschlussmöglichkeit von bis zu 8 digitalen Satelliten Receivern.

Multi-switch MSP 58 Q

High quality multi-switch including a terrestrial aerial input. Connector for up to 8 digital satellite receivers.

EAN	Art.-Nr. item-no.	Länge length	DIY	VPE QTY
4000953	37173 4	-	-	5



Digital Multifeed-LNB-Halter

Befestigung zweier LNB an einer Satellitenantenne ermöglicht den Multifeed-Betrieb. Geeignet für alle Antennen mit rundem LNB-Arm (max. Ø 22mm). Ermöglicht den gleichzeitigen Empfang der Satelliten Astra (19,2°) und Hotbird (13°).

Digital multifeed LNB bracket

Mounting of two LNB's onto one satellite dish allows multifeed operation. Suitable for all dishes with round LNB-arm (max. ø 22 mm). Allows reception of the satellites Astra (19.2°) and Hotbird (13°) at the same time.

EAN	Art.-Nr. item-no.	Länge length	DIY	VPE QTY
40009530	3713 5	-	-	6



SAT-Finder mit optischer und akustischer Anzeige

Empfohlen zur optimalen Ausrichtung der Satellitenantenne. Änderungen in der Empfangsstärke werden mittels Tonhöhe und Farbänderung der LED angezeigt.

SAT-Finder with visual and audible indication

Recommended for the optimum alignment of satellite aerials. Changes in the reception strength are indicated by means of the sound level and the colour change of the LED.

EAN	Art.-Nr. item-no.	Länge length	DIY	VPE QTY
4000953	37351 6	-	-	4



SAT-FinderSet

Unterstützt die Bestimmung der Satellitenposition durch Kompass und das exakte Ausrichten der Außeneinheit mittels optischer und akustischer Signale des Sat-Finders

SAT Finder Kit

Helps to determine correct positioning of the satellite via compass and to carry out exact alignment of the outdoor unit via optical and acoustic sat finder signals

EAN	Art.-Nr. item-no.	Länge length	DIY	VPE QTY
4000953	37355 4	-	-	4



DiSeqC-Antennenumschalter 2/1, wettergeschützt

Kombiniert zwei Satellitenantennen/LNB zum Empfang von unterschiedlichen Satelliten. Empfohlen für die Erstellung einer Multifeed-Anlage.

DiSeqC aerial changeover switch 2/1, weatherproof

Combines two satellite aerials/LNB for the reception of different satellites. Recommended for creating a multi-feed system.

EAN	Art.-Nr. item-no.	Länge length	DIY	VPE QTY
4000953	39321 7	-	-	4



Kabel

Cable

F-Kabel	F cable	12
Sets	Sets	15
Antennen-Kabel	Antenna cable	17
HDMI-Kabel	HDMI cable	20
USB-Kabel	USB cable	22
Scart-Kabel	Scart cable	25
Cinch-Kabel	RCA cable	27
Klinke-Kabel	Jack cable	29
Lichtleiter-Kabel	Optical fibre cable	31
S-VHS-Kabel	S-VHS cable	31
YUV-Kabel	YUV cable	32
Lautsprecher-Kabel	Loudspeaker cable	32
Netzwerk-Kabel	Network cable	33
Monitor-Kabel	Monitor cable	34
Telefon-Kabel	Telephone cable	35
Strom	Power	40

F-KABEL

F CABLE



F-Anschlusskabel

4-fach geschirmtes Koaxialkabel für höchsten Schutz vor Störungen. Professionelle F-Verbindung vermeidet Wackelkontakte und Kurzschlüsse. Geringe Dämpfung durch optimierte Isolier- und Kupfermaterialien. Empfohlen für den perfekten Digitalempfang mit maximaler Bild- und Tonqualität.

F connection cable

Quadruple-shielded coaxial cable for high-level protection against interferences.

Professional F connection prevents loose connections and short circuits. Reduced losses due to optimum insulating and copper materials. Recommended for perfect digital reception with maximum picture and sound quality.

EAN	Art.-Nr. item-no.	Länge length	DIY	VPE QTY
4000953	39151 0	1,5m	-	4
4000953	39161 9	3,0m	-	4
4000953	39171 8	5,0m	-	4

Shielding*
110dB



F-Anschlusskabel

Hochwertiges Koaxialkabel (RG6) mit doppelter Abschirmung ermöglicht hohes Schirmungsmaß (> 90dB). Geringste Dämpfung durch hochwertige Isolier- und Kupfermaterialien.

F cable

High-quality double-screened coaxial cable (RG6) provides a high level of screening (> 90dB). Minimum attuation due to high-quality insulating and copper materials.

EAN	Art.-Nr. item-no.	Länge length	DIY	VPE QTY
4000953	39152 7	1,25m	-	6
4000953	39162 6	2,5m	-	4
4000953	39172 5	5,0m	-	4



F-Anschlusskabel

Doppeltgeschirmt für digital TV.

Standard Koaxialkabelverbindung zwischen Receiver, Anschlussdose und Verteilern.

Farbe: weiß

F cable

Double-screened for digital TV.

Standard coaxial cable between receiver, connecting socket and distributors.

Colour: white

EAN	Art.-Nr. item-no.	Länge length	DIY	VPE QTY
40009530	3805 4	1,25m	-	6
40009530	3806 6	2,5m	-	6
40009530	3807 4	5,0m	-	4
40009530	3808 4	10,0m	-	4
4000953	23705 4	1,5m	•	30
4000953	23706 1	3,0m	•	20
4000953	23699 6	5,0m	•	12
4000953	23707 8	10,0m	•	20



F-Anschlusskabel

Farbe: schwarz

F cable

Colour: black

EAN	Art.-Nr. item-no.	Länge length	DIY	VPE QTY
40009530	3814 9	0,5m	-	4
40009530	3815 6	1,25m	-	6



4-fach-geschirmtes Koaxialkabel

für höchsten Schutz vor Störungen durch Mobiltelefone und Funkanwendungen. Empfohlen für den perfekten Digitalempfang mit maximaler Bild- und Tonqualität. Geringe Dämpfung durch optimierte Isolier- und Kupfermaterialien. Professionelles Koaxialkabel für langlebige Installation und störungsfreien Betrieb.

Quadruple-shielded coaxial cable

for high-level protection against interferences from mobile phones and wireless applications. Recommended for perfect digital reception with maximum picture and sound quality. Reduced losses due to optimum insulating and copper material. Professional coaxial cable for durable installation and trouble-free operation

EAN	Art.-Nr. item-no.	Länge length	DIY	VPE QTY
4000953	38351 5	10,0m	-	20
4000953	38361 4	15,0m	-	5
4000953	38371 3	25,0m	-	5
4000953	38281 5	50,0m	-	1
4000953	38291 4	100,0m	-	1



Digital-Koaxialkabel

Doppelt abgeschirmtes, dämpfungsarmes Koaxialkabel für den Digitalempfang. Optimal für lange Signalwege zwischen Außen-einheit und Receiver. Höchste Qualität gemäß RG6 Kabelstandard für perfekte Bild- und Tonqualität.

Digital coaxial cable

Double screened, low loss coaxial cable for digital reception. Perfect for long signal paths between the outdoor unit and the receiver. Highest quality according to RG6 cable standard for perfect picture and sound quality.

EAN	Art.-Nr. item-no.	Länge length	DIY	VPE QTY
40009530	3835 4	10,0m	-	20
40009530	3836 1	15,0m	-	5
40009530	3837 8	25,0m	-	5
40009530	3828 6	50,0m	-	5
40009530	3827 9	100,0m	-	1
4000953	23770 2	10,0m	•	30
4000953	23771 9	15,0m	•	30
4000953	23772 6	25,0m	•	5
4000953	23773 3	50,0m	•	5



Digital-Koaxialkabel

Doppelt abgeschirmtes Koaxialkabel für den TV-Digitalempfang über SAT oder Antenne. Perfekte Bild- und Tonqualität durch hohes Schirmungsmaß von 75dB.

Digital coaxial cable

Double screened coaxial cable for digital reception of TV via SAT or antenna. Perfect picture and sound quality due to high shielding effectiveness of 75dB.

EAN	Art.-Nr. item-no.	Länge length	DIY	VPE QTY
40009530	3510 0	15,0m	-	20
40009530	3516 2	25,0m	-	10
4000953	23510 4	15,0m	•	10





F-Anschlusskabel mit Koaxial-Stecker

Hochwertiges Koaxialkabel (RG6) mit doppelter Abschirmung ermöglicht hohes Schirmungsmaß (> 80dB). Geringste Dämpfung durch hochwertige Isolier- und Kupfermaterialien.

F cable with coaxial plug

High-quality double-screened coaxial cable (RG6) provides a high level of screening (> 80dB). Minimum attuation due to high-quality insulating and copper materials.

EAN	Art.-Nr. item-no.	Länge length	DIY	VPE QTY
40009530	3696 1	1,5m	-	6
40009530	3697 8	3,0m	-	4
40009530	3698 5	5,0m	-	4



F-Anschlusskabel mit Koaxial-Kupplung

Hochwertiges Koaxialkabel (RG6) mit doppelter Abschirmung ermöglicht hohes Schirmungsmaß (> 80dB). Geringste Dämpfung durch hochwertige Isolier- und Kupfermaterialien.

F cable with coaxial coupling

High-quality double-screened coaxial cable (RG6) provides a high level of screening (> 80dB). Minimum attuation due to high-quality insulating and copper materials.

EAN	Art.-Nr. item-no.	Länge length	DIY	VPE QTY
40009530	3676 3	3,0m	-	4



Fensterdurchführung, wettergeschützt

Korrosionsfreie F-Verbindung mit Wetterschutz verhindert eindringende Feuchtigkeit und Kurzschlüsse. Inklusive Wetterschutz! Langlebige, UV-beständige Kunststoffummantelung. Auch für terrestrischen Fernsehempfang geeignet!

Window bushing, weather protected

Corrosion-proof F connection with weather protection prevents moisture from penetrating and short circuits. Includes weather protection! Durable, UV-resistant plastic coating. Also suitable for terrestrial TV reception!

EAN	Art.-Nr. item-no.	Länge length	DIY	VPE QTY
4000953	37041 6	0,2m	-	4

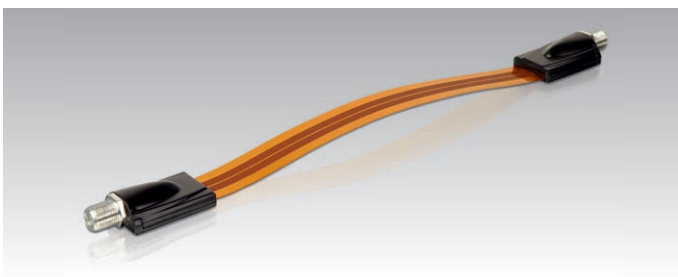

Fensterdurchführung

Sehr belastbares, flaches Koaxialkabel. Zur Verbindung von Außeneinheiten und Receivern ohne zu bohren.

Window feed-through

Very strong, flat coaxial cable. For connecting external units and receivers without drilling.

EAN	Art.-Nr. item-no.	Länge length	DIY	VPE QTY
40009530	3720 3	0,23m	-	4

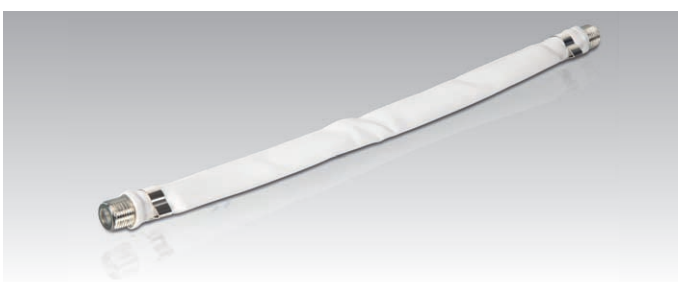

Fensterdurchführung

Sehr belastbares, flaches Koaxialkabel. Zur Verbindung von Außeneinheiten und Receivern ohne zu bohren.

Window feed-through

Very strong, flat coaxial cable. For connecting external units and receivers without drilling.

EAN	Art.-Nr. item-no.	Länge length	DIY	VPE QTY
40009530	3704 3	0,2m	-	4



Optimal für die Installation einer Einteilnehmeranlage. Montagefreundlich und zeitsparend durch vormontierten F-Stecker.

Sat-Anlagen Startset 1 (37511)

10m digitaltaugliches Koaxialkabel,
1x F-Stecker,
1x Wetterschutztülle,
1x Scart-Kabel, 1,5m.

Sat-Anlagen Startset 2 (37512)

20m digitaltaugliches Koaxialkabel,
1x F-Stecker,
1x Wetterschutztülle,
1x Scart-Kabel, 1,5m.

Perfect for the installation of a single-party system. Assembly-friendly and time-saving due to the pre-mounted F plug.

Sat systems Startset 1 (37511)

10m coaxial cable suitable for digital use,
1x F plug,
1x weatherproof case,
1x Scart cable, 1.5m.

Sat systems Startset 2 (37512)

20m coaxial cable suitable for digital use,
1x F plug,
1x weatherproof case,
1x Scart cable, 1.5m.

EAN	Art.-Nr. item-no.	Länge length	DIY	VPE QTY
4000953	37511 4	10,0m	-	40
4000953	37512 1	20,0m	-	20



Digital-Koaxialkabel Set

Doppelt abgeschirmtes Koaxialkabel für Digitalempfang über Satellit inklusive F-Stecker. Ermöglicht den Aufbau einer Einteilnehmeranlage

Perfekte Bild- und Tonqualität durch hohes Schirmungsmaß von 75dB.

25m Koaxialkabel
2x F-Stecker

Digital coaxial cable set

Double screened coaxial cable for digital reception via satellite including F plug. Enables the setup of a single-user system.

Perfect picture and sound quality due to high shielding effectiveness of 75dB.

25m coaxial cable
2x F plug

EAN	Art.-Nr. item-no.	Länge length	DIY	VPE QTY
40009530	3751 7	25,0m	-	10



Zubehörset

20m Koaxialkabel, 2x F-Stecker, 1x Wetterschutztülle

Zum Verbinden einer Satellitenantenne mit einem Receiver inklusive Wetterschutztülle.

Accessory set

20m coaxial cable, 2x F plugs, 1x weatherproof bush

For connecting a satellite aerial to one receiver including weatherproof bush.

EAN	Art.-Nr. item-no.	Länge length	DIY	VPE QTY
40009530	3851 4	20,0m	•	1



Optimal für die Installation einer digitalen Einteilnehmeranlage. Montagefreundlich und zeitsparend durch vormontierten F-Stecker.

HDTV Startset 1 (37519)

10m digitaltaugliches Koaxialkabel,
1x F-Stecker,
1x Wetterschutztülle,
1x High-Speed-HDMI®-Kabel, 1,5m.

HDTV Startset 2 (37520)

20m digitaltaugliches Koaxialkabel,
1x F-Stecker,
1x Wetterschutztülle,
1x High-Speed-HDMI®-Kabel, 1,5m.

Perfect for the installation of a digital single-party system. Assembly-friendly and time-saving due to the pre-mounted F plug.

HDTV Startset 1 (37519)

10m coaxial cable suitable for digital use,
1x F plug,
1x weather proof case,
1x High Speed HDMI® cable, 1.5m.

HDTV Startset 2 (37520)

20m coaxial cable suitable for digital use,
1x F plug,
1x weather proof case,
1x High Speed HDMI® cable, 1.5m.

EAN	Art. -Nr. item-no.	Länge length	DIY	VPE QTY
4000953	37519 3	10,0m	-	20
4000953	37520 6	20,0m	-	20





Antennen-Anschlusskabel Premium Line

4-fach-geschirmtes Koaxialkabel (110 dB*) für höchsten Schutz vor Störungen. Professionelle, Goldkontakte vermeiden Wackelkontakte und Kurzschlüsse. Geringste Dämpfung durch optimierte Isolier- und Kupfermaterialien. Empfohlen für den perfekten Digitalempfang mit maximaler Bild- und Tonqualität.

Premium Line aerial cable

Quadruple-shielded coaxial cable (>110 dB*) for high-level protection against interferences. Professional high-quality gold contacts prevents loose connections and short circuits. Minimum attenuation due to high-quality insulating and copper materials. Recommended for perfect digital reception with maximum picture and sound quality.

EAN	Art.-Nr. item-no.	Länge length	DIY	VPE QTY
40009530	3334 2	1,5m	-	4
40009530	3335 9	3,0m	-	4
40009530	3336 6	5,0m	-	4
40009530	3337 3	10,0m	-	4

Shielding*
110dB



Antennen-Anschlusskabel, hochwertig

Hochwertiges Koaxialkabel (RG6) mit doppelter Abschirmung ermöglicht hohes Schirmungsmaß (> 80dB). Hervorragender Schutz vor Bildstörungen durch Funkanwendungen.

Aerial cable, high-quality

High-quality double-screened coaxial cable (RG6) provides a high level of screening (> 80dB). Outstanding protection against picture interference from radio applications.

EAN	Art.-Nr. item-no.	Länge length	DIY	VPE QTY
40009530	3920 7	1,5m	-	6
40009530	3921 4	3,0m	-	4
40009530	3922 1	5,0m	-	4
40009530	3923 8	10,0m	-	4



Antennenkabel mit Mantelstromfilter

Integrierte Mantelstromfilter schützen vor hochfrequenten Störungen. Optimiert die Bildqualität bei 100 Hz-Fernsehern und Digitalempfang.

Aerial cable with screen current filter

Integral screen current filters protect against high frequency interference. Maximises the picture quality of 100 Hz TV sets and digital reception.

EAN	Art.-Nr. item-no.	Länge length	DIY	VPE QTY
40009530	3528 5	1,5m	-	6
40009530	3532 2	3,0m	-	6
40009530	3595 7	5,0m	-	4
40009530	3596 4	10,0m	-	4



Antennenkabel

Doppeltgeschirmt für analog und digital TV. Standard Koaxialkabelverbindung zwischen TV, VCR, Anschlussdose und Verteilern.

Aerial cable

Double-screened for analogue and digital TV. Standard coaxial cable between TV, VCR, connecting socket and distributors.

EAN	Art.-Nr. item-no.	Länge length	DIY	VPE QTY
4000953	3505 0	0,75m	-	6
40009530	3505 6	1,5m	-	6
40009530	3506 3	3,0m	-	6
40009530	3507 0	5,0m	-	4
40009530	3509 4	7,5m	-	4
40009530	3508 7	10,0m	-	4
4000953	23505 0	1,5m	•	30
4000953	23506 7	3,0m	•	20
4000953	23507 4	5,0m	•	12
4000953	23509 8	7,5m	•	20
4000953	23508 1	10,0m	•	20
4000953	23511 1	15,0m	•	12



Antennenkabel

Doppeltgeschirmt für analog und digital TV. Standard Koaxialkabelverbindung zwischen TV, VCR, Anschlussdose und Verteilern.

Aerial cable

Double-screened for analogue and digital TV. Standard coaxial cable between TV, VCR, connecting socket and distributors.

EAN	Art.-Nr. item-no.	Länge length	DIY	VPE QTY
40009530	3500 1	1,5m	-	6
40009530	3501 8	3,0m	-	4
40009530	3502 5	5,0m	-	4
40009530	3504 9	10,0m	-	4
4000953	23500 5	1,5m	•	30
4000953	23501 2	3,0m	•	20
4000953	23502 9	5,0m	•	12
4000953	23503 6	7,5m	•	8
4000953	23504 3	10,0m	•	6



Antennenkabel, gewinkelt

Optimiert Kabelführung und Verlegung. Gewinkelte Antennenkupplung ermöglicht unauffällige Kabelführung zwischen Anschlussdose und TV Gerät.

Aerial cable, angled

Optimised cable routing and laying. Angled aerial coupling enables discreet cable routing between connecting socket and TV set.

EAN	Art.-Nr. item-no.	Länge length	DIY	VPE QTY
4000953	33505 7	1,5m	-	6
4000953	33506 4	3,0m	-	6
4000953	33507 1	5,0m	-	6
4000953	33509 5	7,5m	-	4
4000953	33508 8	10,0m	-	4



Digital-Koaxialkabel

Doppelt abgeschirmtes Koaxialkabel für TV-Digitalempfang über Sat oder Antenne. Perfekte Bild- und Tonqualität durch hohes Schirmungsmaß von 75dB.

Digital coaxial cable

Double screened coaxial cable for digital reception of TV via sat or antenna. Perfect picture and sound quality due to high shielding effectiveness of 75dB.

EAN	Art.-Nr. item-no.	Länge length	DIY	VPE QTY	
40009530	3518	6	25,0m	-	10
40009530	3519	3	50,0m	-	10



Fensterdurchführung-Set

Ohne Bohren – durch Fensterrahmen und Hauswänden. Inklusive 2 Adapter von F- auf Koaxialbuchse und auf Koaxialstecker, um z.B. DVB-T Außenantennen direkt anschließen zu können.

Window Bushing Set

No drilling required – through window frames and walls. Includes 2 adapters for F to coaxial socket and to coaxial plug, e.g., to directly connect DVB-T outdoor antennas.

EAN	Art.-Nr. item-no.	Länge length	DIY	VPE QTY	
4000953	33704	4	0,2m	-	4



High-Speed-HDMI®-Kabel mit Ethernet

- 4096 x 2160 Pixel-volldigitales HDMI Kabel
- 3D-Übertragung für Spiele-/Video-Inhalte der neuesten Generation
- 10,2 GB/s Datenübertragungsrate
- Netzwerkfähigkeit (Internet/ 100 MB/s)
- Audio Return Channel (ARC)
- Abwärtskompatibel zu bestehenden Standards

High Speed HDMI® Cable with Ethernet

- 4096 x 2160 pixel fully digital HDMI cable
- 3D transfer for next-generation game / video content
- 10.2 GB/s data transfer rate
- Network-compatible (Internet/ 100 MB/s)
- Audio Return Channel (ARC)
- Downward compatibility with existing standards

EAN	Art.-Nr. item-no.	Länge length	DIY	VPE QTY
40009530	3283 3	0,5m	-	1
40009530	3274 1	1,5m	-	4
4000953	81515 3	2,0m	-	1
40009530	3271 0	3,0m	-	1
4000953	81516 0	4,0m	-	1



High-Speed-HDMI®-Kabel

- Unterstützt hochauflösendes Full-HDTV (1080p)
- Ergonomisches, exklusives Steckerdesign
- Mit Mantelstromfilter – zur Vermeidung von Störeinflüssen hochfrequenter Strahlung (z.B. Handy, DECT-Telefone)
- Doppelt geschirmt – zur Vermeidung äußerer Störstrahlung
- Vergütete Kontaktflächen – beugt Korrosion vor

High Speed HDMI® Cable

- Supports high-resolution full HDTV (1080p)
- Ergonomic, exclusive plug design
- With sheath current filter – to prevent interference from high-frequency radiation (e.g. mobile phones, DECT telephones)
- Double shielded – to prevent external interference radiation
- Tempered contact surfaces – to prevent corrosion

EAN	Art.-Nr. item-no.	Länge length	DIY	VPE QTY
40009530	2961 1	1,5m	-	4
40009530	2963 5	3,0m	-	4
40009530	2965 9	5,0m	-	4



High-Speed-HDMI®-Kabel

- HDMI (High Definition Multimedia Interface) unterstützt High Definition Video und ist optimal für die Verbindung digitaler Wiedergabe- und Quellgeräte.
- Übertragung von unkomprimiertem, volldigitalem High Definition Video sowie unkomprimiertem, digitalen Mehrkanal-Audio sowie Kopierschutzdaten/-signale.
- Rein digitale Übertragung (keine D/A oder A/D-Wandlung)

High Speed HDMI® Cable

- HDMI (High Definition Multimedia Interface) supports High Definition Video and is ideal for connecting digital playback and source devices.
- Transfer of uncompressed, fully digital High Definition Video as well as uncompressed, digital multi-channel audio and copy protected data/ signals.
- Pure digital transfer (no D/A or A/D-conversion)

EAN	Art.-Nr. item-no.	Länge length	DIY	VPE QTY
40009530	3240 6	1,5m	-	4





High-Speed-HDMI®-Kabel

HDMI-Stecker – HDMI-Stecker

High Speed HDMI® Cable

HDMI plug – HDMI plug

EAN	Art.-Nr. item-no.	Länge length	DIY	VPE QTY
4000953	25052 7	1,5m	•	25
4000953	25054 1	3,0m	•	25
4000953	25055 8	5,0m	•	25



High-Speed-HDMI®-Kabel mit Ethernet

HDMI-Stecker – HDMI-Stecker, mit Rotation

- 4096 x 2160 Pixel-volldigitales HDMI-Kabel
- 3D-Übertragung für Spiele-/Video-Inhalte der neuesten Generation
- Netzwerkfähigkeit (Internet/ 100 MB/s)
- Audio Return Channel (ARC)
- Abwärtskompatibel zu bestehenden Standards

High-Speed-HDMI® Cable with Ethernet

HDMI-plug – HDMI-plug, with rotation

- 4096 x 2160 pixel fully digital HDMI cable
- 3D transfer for next-generation game / video content
- Network-compatible (Internet/ 100 MB/s)
- Audio Return Channel (ARC)
- Downward compatibility with existing standards

EAN	Art.-Nr. item-no.	Länge length	DIY	VPE QTY
40009530	3267 3	1,5m	–	1
40009530	3280 2	3,0m	–	1

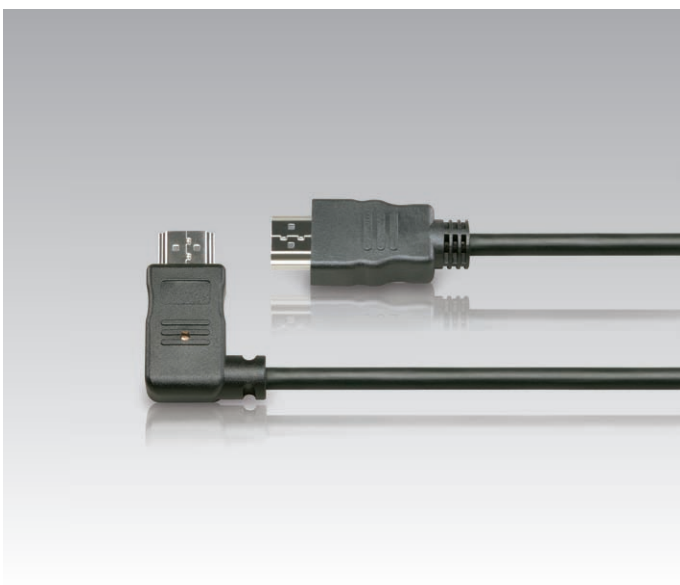

High-Speed-HDMI®-Kabel

HDMI-Stecker – HDMI-Stecker, 90° gewinkelt

High Speed HDMI® Cable

HDMI plug – HDMI plug, 90° angled

EAN	Art.-Nr. item-no.	Länge length	DIY	VPE QTY
4000953	25059 6	1,5m	•	25



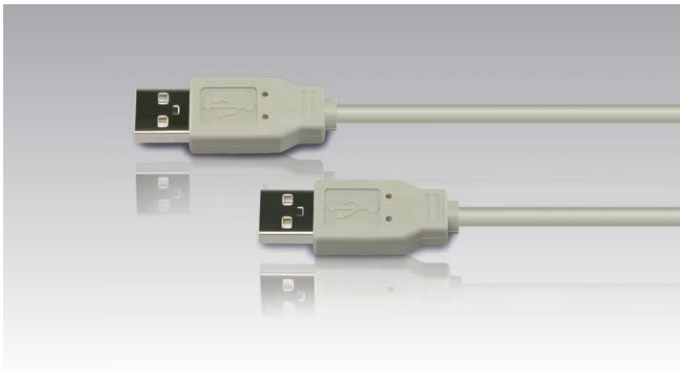

USB 2.0 Anschlusskabel

USB 2.0 A-Stecker – USB 2.0 A-Stecker
Zum Anschluss eines USB 2.0 oder USB 1.1 tauglichen Endgerätes an den Computer. Datenrate bis zu 480 Mbs

USB 2.0 connector cable

USB 2.0 A plug – USB 2.0 A plug
For connecting a USB 2.0 or USB 1.1 suitable end device to a computer. Data rate up to 480Mbps

EAN	Art.-Nr. item-no.	Länge length	DIY	VPE QTY
4000953	81179 7	1,8m	-	6

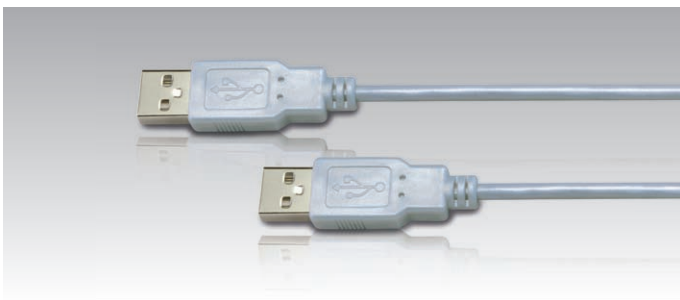

USB 2.0 Anschlusskabel

USB 2.0 A-Stecker – USB 2.0 A-Stecker

USB 2.0 connector cable

USB 2.0 A plug – USB 2.0 A plug

EAN	Art.-Nr. item-no.	Länge length	DIY	VPE QTY
4000953	81180 3	1,2m	•	30



USB 2.0 Anschlusskabel

USB 2.0 A-Stecker – USB 2.0 B-Stecker.
Zum Anschluss eines USB 2.0 oder USB 1.1 tauglichen Endgerätes an den Computer. Datenrate bis zu 480 Mbs.

USB 2.0 connector cable

USB 2.0 A plug – USB 2.0 B plug.
For connecting a USB 2.0 or USB 1.1 suitable end device to a computer. Data rate up to 480Mbps.

EAN	Art.-Nr. item-no.	Länge length	DIY	VPE QTY
40009530	8122 0	3,0m	-	6
40009530	8121 3	5,0m	-	4

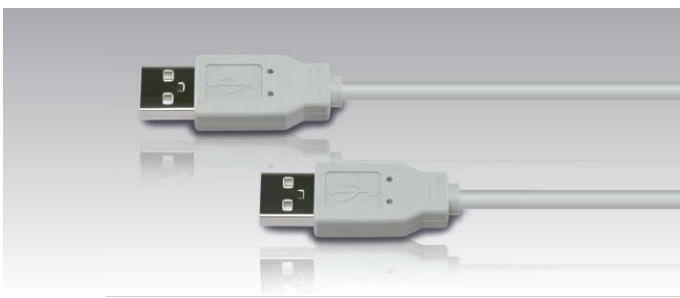

USB 2.0 Anschlusskabel

USB 2.0 A-Stecker – USB 2.0 A-Stecker.

USB 2.0 connector cable

USB 2.0 A plug – USB 2.0 A plug.

EAN	Art.-Nr. item-no.	Länge length	DIY	VPE QTY
4000953	28297 9	1,5m	•	50

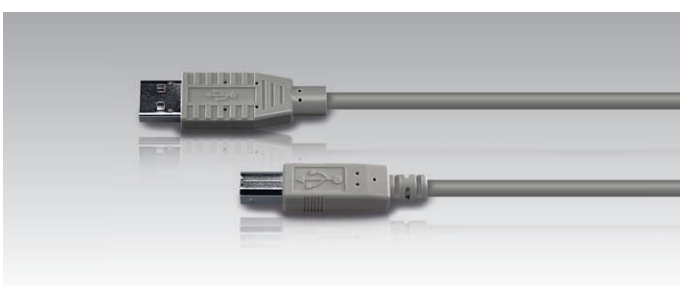

USB 2.0 Anschlusskabel

USB 2.0 A-Stecker – USB 2.0 B-Stecker.

USB 2.0 connector cable

USB 2.0 A plug – USB 2.0 B plug.

EAN	Art.-Nr. item-no.	Länge length	DIY	VPE QTY
4000953	28273 3	2,0m	•	50
4000953	28272 6	3,0m	•	50

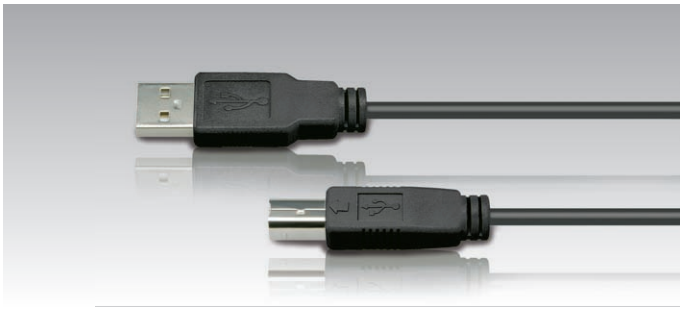

USB 2.0 Anschlusskabel

USB 2.0 A-Stecker – USB 2.0 B-Stecker.

USB 2.0 connector cable

USB 2.0 A plug – USB 2.0 B plug.

EAN	Art.-Nr. item-no.	Länge length	DIY	VPE QTY
4000953	28290 0	2,0m	•	50
4000953	28291 7	3,5m	•	50
4000953	28292 4	4,5m	•	50

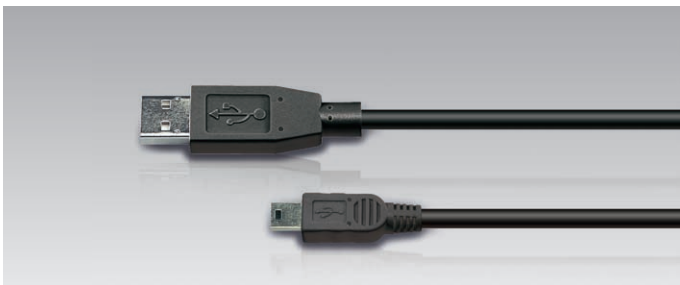

Mini USB 2.0 Adapterkabel

Mini USB B-Stecker auf USB A-Stecker.

Zum Adaptieren von einem Mini USB B-Stecker an ein USB A-Steckerkabel, z.B. für Digitalkameras.

Mini USB 2.0 adapter cable

Mini USB B plug to USB A plug.

For adapting a mini USB B plug to a USB A plug connecting cable, e.g. for digital cameras.

EAN	Art.-Nr. item-no.	Länge length	DIY	VPE QTY
40009530	8124 4	3,0m	–	6
4000953	81251 0	2,0m	•	30

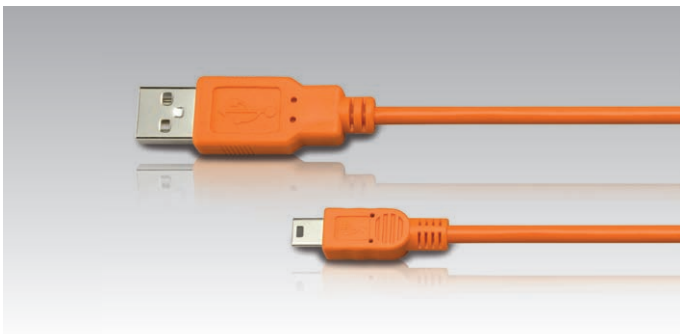

Mini USB 2.0 Adapterkabel

Mini USB B-Stecker auf USB A-Stecker.

Zum Adaptieren von einem Mini USB B-Stecker an ein USB A-Steckerkabel, z.B. für Digitalkameras.

Mini USB 2.0 adapter cable

Mini USB B plug to USB A plug.

For adapting a mini USB B plug to a USB A plug connecting cable, e.g. for digital cameras.

EAN	Art.-Nr. item-no.	Länge length	DIY	VPE QTY
4000953	81252 7	1,0m	•	30



Micro-USB Verbindungskabel

USB A – USB Micro B

Zum Datenaustausch zwischen PC/Notebook und Peripheriegeräten mit USB Micro-B Anschluss (z.B. für Handys und Digitalkameras). USB 2.0 Standard. Übertragungsrate bis zu 480MBit/s.

Micro-USB connecting cable

USB A – USB Micro-B

For the exchange of data between PCs/notebooks and peripheral devices with USB Micro-B connections (e.g. mobile phones and digital cameras). USB 2.0 standard. Transfer rate up to 480 MBit/s.

EAN	Art.-Nr. item-no.	Länge length	DIY	VPE QTY
40009530	8263 0	1,0m	–	6

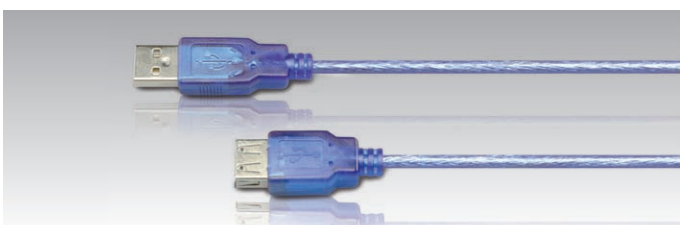

USB 2.0 Verlängerungskabel

USB A-Stecker – USB A-Buchse

USB extension cable

USB A plug – USB A socket

EAN	Art.-Nr. item-no.	Länge length	DIY	VPE QTY
4000953	81161 2	1,5m	•	30



USB 2.0 Docking Station

Die Verlängerung (USB A-Stecker – USB A-Buchse) des USB-Anschlusses vom PC auf den Schreibtisch. Die Station erleichtert bspw. das Synchronisieren des MP3-Players oder die Datenübertragung auf einen USB Stick ohne lästiges Bücken. Der Anschluss erfolgt einfach an den USB Anschluss des Computers. Sicherer Halt dank schwerem Sockel.

USB 2.0 Docking Station

Extension (USB A connector – USB A socket) of the USB connection from the PC onto your desk. This station facilitates, e.g., synchronisation of an MP3 player or data transfer to a USB stick without you having to bend down. Simply connect it to the computer's USB port. Secure fixing due to a heavy base.

EAN	Art.-Nr. item-no.	Länge length	DIY	VPE QTY
4000953	81171 1	1,5m	-	6



USB Verlängerungskabel

USB A-Stecker – USB A-Buchse.
Zum passiven Verlängern von USB Anschlusskabeln.

USB extension cable

USB A plug – USB A socket.
For passively extending USB connection cables.

EAN	Art.-Nr. item-no.	Länge length	DIY	VPE QTY
4000953	81174 2	2,5m	-	6
4000953	81175 9	3,5m	-	6

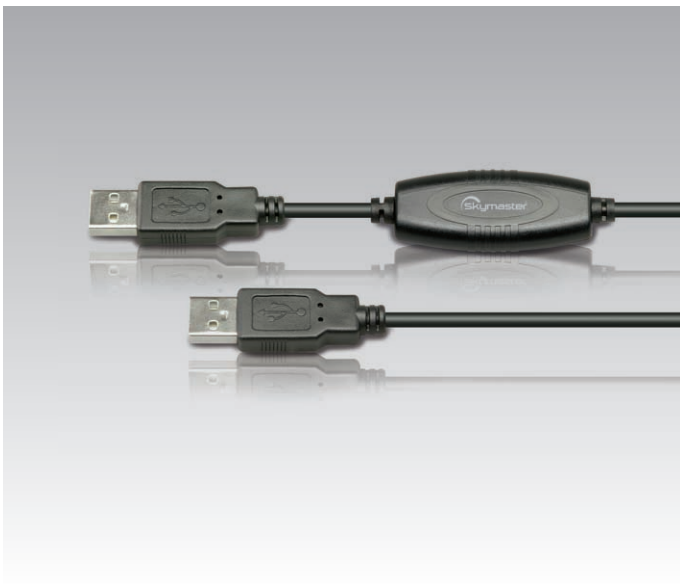

USB 2.0 Data Link Kabel

USB A-Stecker – USB A-Stecker.
Link Kabel zum direkten Datenaustausch von PC zu PC. Einfaches Austauschen von Dateien durch Drag und Drop. Plug und Play Installation. Administratorenrechte benötigt.
Windows XP, Windows Vista, Windows 7

USB 2.0 Data Link Cable

USB A plug – USB A plug.
Link cable for the direct exchange of data between PCs. Simple transfer of data by drag and drop. Plug and play installation. Administrator rights required.
Windows XP, Windows Vista, Windows 7

EAN	Art.-Nr. item-no.	Länge length	DIY	VPE QTY
4000953	85914 0	2,0m	-	6



Scart-Kabel

Scart-Stecker – Scart-Stecker, vergoldet
Hochwertiges A/V-Verbindungskabel. Voll beschaltet, 21-polig, S-VHS tauglich, sauerstofffreie Signalleitungen (OFC – Oxygen Free Copper). 3-fach geschirmt (Gruppen- und Einzelschirmung).

Scart Cable

Scart plug – Scart plug, gold plated
High-quality A/V connection cable. Fully connected, 21-pole, S-VHS suitable, oxygen free signal cables (OFC – Oxygen Free Copper). triple shielded (group and individual shielding).

EAN	Art.-Nr. item-no.	Länge length	DIY	VPE QTY
4000953	2630 6	1,5m	·	25



Scart-Verbindung

Scart-Stecker – Scart-Stecker, vergoldet

- Ergonomisches, exklusives Steckerdesign
- Doppelt geschirmt (Einzelschirmung/Schirmgeflecht)
- Vollbeschaltet (21-polig)
- Vergütete Kontaktflächen – beugt Korrosion vor
- Leistungsstarke A/V-Verbindung für kräftige Farben, höhere Farbgenauigkeit und Bildschärfe.
- Detailreiche, präzise Tonübertragung durch separaten Leiter im Scart-Kabel.

Scart connector

Scart plug – Scart plug, gold plated

- Ergonomic, exclusive plug design
- Double shielded (individual shielding/braided shield)
- Fully connected (21-pole)
- Tempered contact surfaces – to prevent corrosion
- High-performance A/V connector for bright colours and greater colour precision and picture definition.
- Detailed and precise sound transmission due to separate conductor in the Scart cable

EAN	Art.-Nr. item-no.	Länge length	DIY	VPE QTY
40009530	2968 0	1,5m	–	4



Scart-Kabel

Scart-Stecker – Scart-Stecker. Voll beschaltet, 21-polig
Ermöglicht Aufnahme und Wiedergabe aller Signale der angeschlossenen Geräte. S-VHS tauglich.

Scart cable

Scart plug – Scart plug. Fully wired, 21-pin
Enables recording and replay of all signals of the devices connected. Suitable for S-VHS.

EAN	Art.-Nr. item-no.	Länge length	DIY	VPE QTY
40009530	3223 9	1,0m	–	4
40009530	3281 9	2,0m	–	4



Scart-Kabel, geschirmt

Scart-Stecker – Scart-Stecker, vergoldet, voll beschaltet

Scart cable, shielded

Scart plug – Scart plug, gold-plated, fully wired

EAN	Art.-Nr. item-no.	Länge length	DIY	VPE QTY
40009530	2523 1	1,5m	•	25
4000953	25036 7	5,0m	•	12



Scart-Kabel

Scart-Stecker – Scart-Stecker, voll beschaltet

Scart cable

Scart plug – Scart plug, fully wired

EAN	Art.-Nr. item-no.	Länge length	DIY	VPE QTY
4000953	25071 8	1,5m	•	25
4000953	25073 2	3,0m	•	20
4000953	25075 6	5,0m	•	12



Scart-Kabel, geschirmt

Scart-Stecker – Scart-Stecker, voll beschaltet

Scart cable, shielded

Scart plug – Scart plug, fully wired

EAN	Art.-Nr. item-no.	Länge length	DIY	VPE QTY
40009530	2501 9	1,5m	•	50



Camcorder-Verbindung

1x Scart-Stecker – 3x Cinch-Stecker. Signalrichtung umschaltbar.

Camcorder connection

1x Scart plug – 3x phono plug. Signal direction reversible.

EAN	Art.-Nr. item-no.	Länge length	DIY	VPE QTY
40009530	2531 6	1,5m	–	6

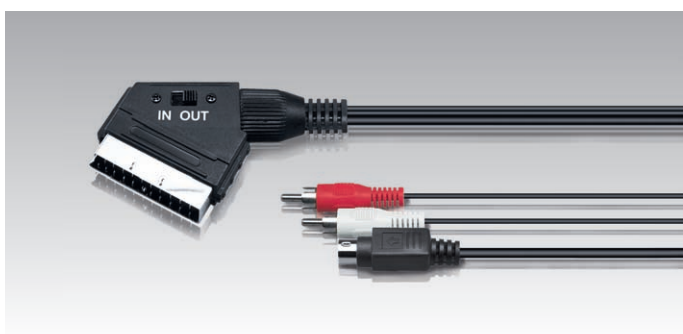

Verbindungskabel Scart–S-VHS/Cinch (mit Umschalter)

Scart-Stecker – 1x S-VHS-Stecker/2x Cinchstecker (Audio L/R). Zum Anschluss eines Camcorders oder Videorecorders mit S-VHS- und Cinchanschlüssen an TV oder Videorecorder mit Scartbuchsen. Signalrichtung umschaltbar.

Scart S-VHS/Cinch connection cable (with a change-over switch)

Scart plug – 1x S-VHS plug/2x Cinch plug (audio L/R). For connecting a camcorder or VCR with S-VHS and Cinch outputs to a TV or VCR with Scart socket. Switchable signal direction

EAN	Art.-Nr. item-no.	Länge length	DIY	VPE QTY
40009530	3131 7	2,0m	–	4

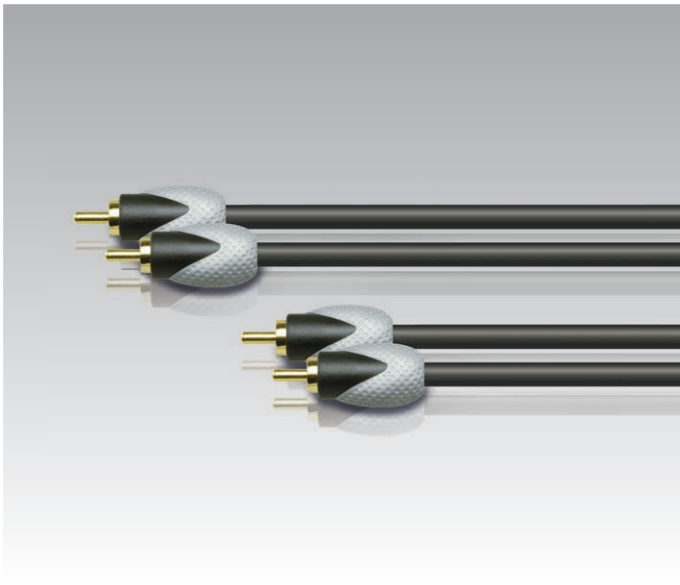

Cinch-Verbindung

2x Cinch-Stecker – 2x Cinch-Stecker.

- Ergonomisches, exklusives Steckerdesign
- Mit Schirmung – zur Vermeidung äußerer Störstrahlung
- Vergütete Kontaktflächen – beugt Korrosion vor
- Analoge Audio-Verbindung gängiger HiFi-Komponenten untereinander (z.B. CD-Player an Verstärker)

Cinch connector

2x Cinch plug – 2x Cinch plug.

- Ergonomic, exclusive plug design
- Shielded – to prevent external interference radiation
- Tempered contact surfaces –to prevent corrosion
- Analogue audio interconnection of common hifi components (e.g. CD player to an amplifier)

EAN	Art.-Nr. item-no.	Länge length	DIY	VPE QTY
40009530	2898 0	1,5m	–	4



Cinch-Kabel

2x Cinch-Stecker – 2x Cinch-Stecker.

Zur Verbindung gängiger HiFi, VCR, DVD, etc. Komponenten untereinander.

Phono cable

2x phono plugs – 2x phono plugs.

For connecting standard HiFi, VCR, DVD, etc. components together.

EAN	Art.-Nr. item-no.	Länge length	DIY	VPE QTY
40009530	3152 2	1,5m	–	6
40009530	3165 2	5,0m	–	6
4000953	23152 6	1,5m	•	15
4000953	23155 7	3,0m	•	15
4000953	23165 6	5,0m	•	15
4000953	23157 1	10,0m	•	25



Cinch-Verlängerungskabel

2x Cinch-Kupplungen – 2x Cinch-Stecker.

Zur Verlängerung von Cinch-Anschlüssen und -Kabeln.

Phono extension cable

2x phono connectors – 2x phono plugs.

For extension of phono connections and cables.

EAN	Art.-Nr. item-no.	Länge length	DIY	VPE QTY
40009530	3167 6	5,0m	–	4
4000953	23163 2	10,0m	•	15

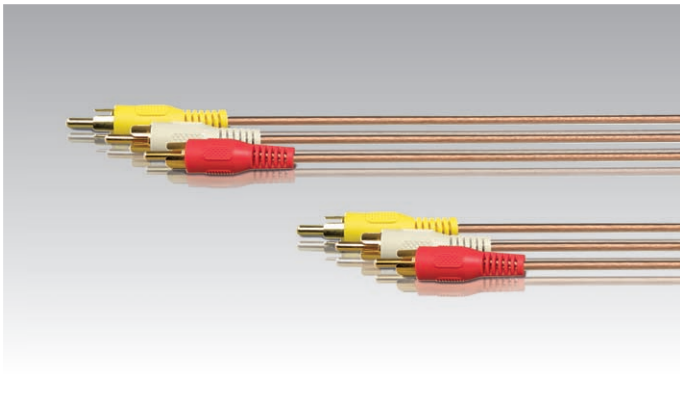

Cinch-Verbindung, transparent, vergoldet

3x Cinch-Stecker – 3x Cinch-Stecker.

Zur Verbindung gängiger HiFi, VCR, DVD, etc. Komponenten untereinander.

Cinch connection, transparent, gold-plated

3x Cinch plug – 3x Cinch plug.

For connecting common components of HiFi, VCR, DVD, etc to one another.

EAN	Art.-Nr. item-no.	Länge length	DIY	VPE QTY
40009530	3214 7	1,5m	-	6
40009530	3216 1	5,0m	-	4

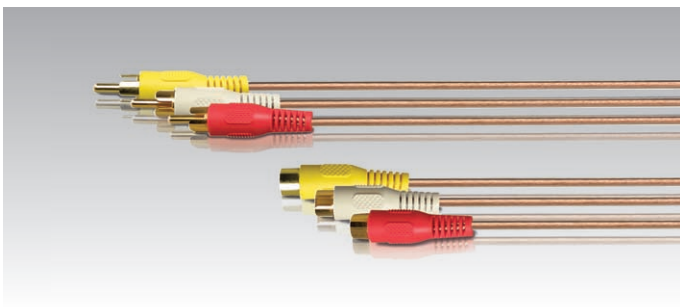

Cinch-Verlängerung, transparent, vergoldet

3x Cinch-Stecker – 3x Cinch-Kupplung.

Zur Verlängerung von Audio-/ Video-Cinchverbindungen.

Cinch extension, transparent, gold plated

3x Cinch plug – 3x Cinch connector.

For extending audio/video cinch connectors.

EAN	Art.-Nr. item-no.	Länge length	DIY	VPE QTY
40009530	3210 9	5,0m	-	4



Digital-Audio-Cinchverbindung, (koaxial)

1x Cinch-Stecker – 1x Cinch-Stecker, vergoldet.

Hochwertiges Kabel mit vergoldeten Kontakten für optimalen Klang.

Digital audio phono connection, (coaxial)

1x phono plug – 1x phono plug, gold-plated.

High quality cable with gold-plated contacts for optimal sound.

EAN	Art.-Nr. item-no.	Länge length	DIY	VPE QTY
40009530	2955 9	2,0m	-	6



Universal Cinch-Anschluss-Set

Universell einsetzbares Cinch-Anschluss-Set für Anschluss, Verlängerung oder Adaptierung gängiger Endgeräte (z.B. MP3-Player, Kopfhörer). Zur Verbindung mit Stereoanlage, PC oder untereinander.

- Cinch-Kabel (2x Cinch-Stecker – 2x Cinch-Stecker), 2,5 m
- Cinch-Kompaktadapter (3,5mm Klinken-Stecker, stereo – 2x Cinch-Kupplung)
- Klinken-Kompaktadapter (6,3mm Klinken-Stecker, stereo – 3,5mm Klinken-Kupplung, stereo)
- Cinch-Kupplung-Adapter (Cinch-Kupplung – Cinch-Kupplung), 2 Stk.

Universal Cinch Connection Set

All-purpose Cinch connection set for connecting, extending or adapting common end devices (e.g. MP3 player, headphones). For connecting to a stereo system or PC, or for interconnections.

- Cinch cable (2x Cinch plug – 2x Cinch plug), 2.5 m
- Compact Cinch adapter (3.5 mm jack plug, stereo – 2x Cinch connector)
- Compact jack adapter (6.3 mm jack plug, stereo – 3.5 mm jack connector, stereo)
- Cinch connector adapter (Cinch connector – Cinch connector), 2 pcs

EAN	Art.-Nr. item-no.	Länge length	DIY	VPE QTY
40009530	3110 2	2,5m	-	6

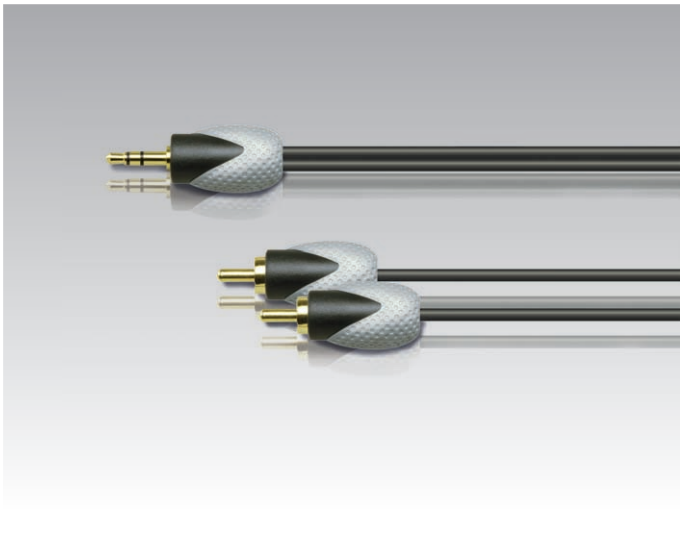

Klinke/Cinch-Verbindung

Klinken-Stecker (3,5mm) – 2x Cinch-Stecker.

- Ergonomisches, exklusives Steckerdesign
- Vergütete Kontaktflächen – beugt Korrosion vor
- Zur Verbindung von Audio-Geräten mit 3,5mm Klinken-Kupplungen (z.B. MP3/CD-Player) mit Cinch-Eingängen (z.B. Stereoanlage).

Jack/Cinch connector

Jack plug (3.5mm) – 2x Cinch plug.

- Ergonomic, exclusive plug design
- Tempered contact surfaces – to prevent corrosion
- For connecting audio devices with 3.5mm jack connectors (e.g. MP3/CD player) to Cinch inputs (e.g. stereo system)

EAN	Art.-Nr. item-no.	Länge length	DIY	VPE QTY
40009530	2820 1	1,5m	–	4



Klinke/Cinch-Verbindung

2x Cinch-Stecker – Klinken-Stecker 3,5 mm

Jack/Cinch connector

2x Cinch plugs – Jack plug 3.5 mm

EAN	Art.-Nr. item-no.	Länge length	DIY	VPE QTY
40009530	3041 9	0,5m	–	6
40009530	3141 6	1,5m	–	6
40009530	3143 0	3,0m	–	6
40009530	8144 2	5,0m	–	4



Klinken-Verbindung 3,5mm

Stereo Klinken-Stecker, beidseitig

Jack connection 3.5mm

Stereo jack plug, both ends

EAN	Art.-Nr. item-no.	Länge length	DIY	VPE QTY
40009530	3168 3	0,5m	–	6
40009530	3118 8	1,5m	–	6
40009530	3138 6	3,0m	–	6
4000953	23139 7	5,0m	•	25



Kopfhörer-Verlängerung

Klinken-Stecker 3,5mm – Klinken-Kupplung 3,5mm, 3-polig
Zur Verlängerung von Anschlüssen (z.B. Kopfhörer) mit 3,5mm Klinken-Stecker.

Headphone extension

Jack plug 3.5mm – jack socket 3.5mm, 3-pole

For extension of connections (e.g. headphones) with 3.5mm jack plug.

EAN	Art.-Nr. item-no.	Länge length	DIY	VPE QTY
40009530	3207 9	1,5m	–	6
40009530	3203 1	3,0m	–	4
40009530	3202 4	5,0m	–	4
4000953	23202 8	5,0m	•	15



Kopfhörer-Verlängerung

Klinken-Stecker 6,3 mm – Klinken-Kupplung 6,3 mm, 3-polig.
Zur Verlängerung von Anschlüssen (z.B. Kopfhörer) mit 6,3 mm Klinken-Stecker.

Headphones extension

Jack plug 6.3 mm – jack line socket 6.3 mm, 3-pin.
For extending connectors (e.g. headphones) with 6.3 mm jack plugs.

EAN	Art.-Nr. item-no.	Länge length	DIY	VPE QTY
40009530	3204 8	5,0m	–	6



Universal Klinken-Anschluss-Set (3,5/6,3 mm)

Universell einsetzbares Klinken-Anschluss-Set für Anschluss, Verlängerung oder Adaptierung gängiger Endgeräte (z.B. MP3-Player, Kopfhörer). Zur Verbindung mit Stereoanlage, PC oder untereinander.

- Klinken-Verlängerung (Klinken-Stecker, stereo – Klinken-Kupplung, stereo), 2,5m
- Klinken-Kompaktadapter (6,3mm Klinken-Stecker, stereo – 3,5mm Klinken-Kupplung, stereo)
- Klinken-Kompaktadapter (3,5mm Klinken-Stecker, stereo – 6,3mm Klinken-Kupplung, stereo)
- Klinken-Stecker-Adapter (3,5mm Klinken-Stecker, stereo – 3,5mm Klinken-Stecker, stereo)
- Klinken-Kompaktadapter (3,5mm Klinken-Stecker, stereo – 2x 3,5mm Klinken-Kupplung, stereo)

Universal Jack Connection Set (3.5/6.3 mm)

All-purpose jack connection set for connecting, extending or adapting common end devices (e.g. MP3 player, headphones). For connecting to a stereo system or PC, or for interconnections.

- Jack extension (Jack plug, stereo – jack connector, stereo), 2.5 m
- Compact jack adapter (6.3 mm jack plug, stereo – 3.5 mm jack connector, stereo)
- Compact jack adapter (3.5 mm jack plug, stereo – 6.3 mm jack connector, stereo)
- Jack plug adapter (3.5 mm jack plug, stereo – 3.5 mm jack plug, stereo)
- Compact jack adapter (3.5 mm jack plug, stereo – 2x 3.5 mm jack connector, stereo)

EAN	Art.-Nr. item-no.	Länge length	DIY	VPE QTY
40009530	3109 6	2,5m	–	6



ODT-Lichtleiterkabel

Toslink-Stecker – Toslink-Stecker.

- Ergonomisches, exklusives Steckerdesign
- ODT-Lichtleiterkabel zur verlustarmen digitalen Audio-Signalübertragung (z.B. DVD-Player und Surround-Verstärker)
- Digitale optische Kabel übertragen digitale Audiosignale in Form von Lichtimpulsen, wodurch Interferenzen nahezu ausgeschlossen werden.

ODT fibre-optic cable

Toslink plug – Toslink plug.

- Ergonomic, exclusive plug design
- ODT optical fibre cable for low loss digital audio signal transmission (e.g. DVD player and surround amplifier)
- Digital optical cables transmit digital audio signals as pulses of light, thus almost completely eliminating interferences

EAN	Art.-Nr. item-no.	Länge length	DIY	VPE QTY
40009530	2828 7	1,5m	-	4



ODT-Lichtleiterkabel

Toslink-Stecker – Toslink-Stecker

Für Geräte mit digitalen Ein- und Ausgängen, optimale Tonqualität.

ODT fibre-optic cable

Toslink plug – Toslink plug

For devices with digital inputs and outputs, optimal sound quality.

EAN	Art.-Nr. item-no.	Länge length	DIY	VPE QTY
40009530	2601 6	1,5m	-	6

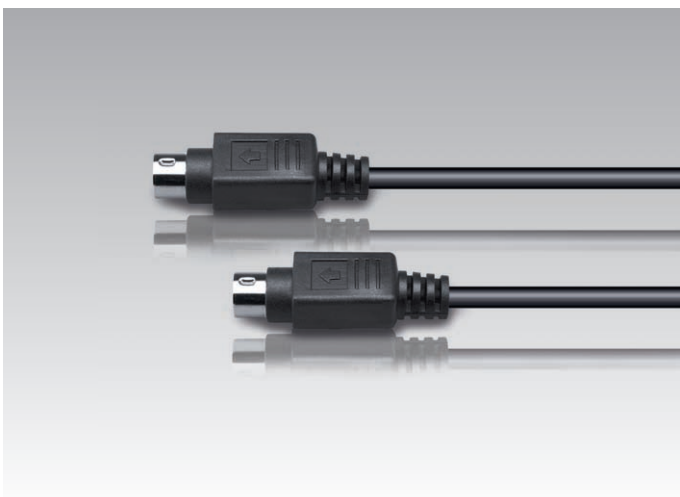

S-VHS-Verbindungskabel

S-VHS-Stecker – S-VHS-Stecker

S-VHS cable

S-VHS-plug – S-VHS-plug

EAN	Art.-Nr. item-no.	Länge length	DIY	VPE QTY
40009530	2505 7	2,0m	-	6
40009530	2508 8	5,0m	-	6

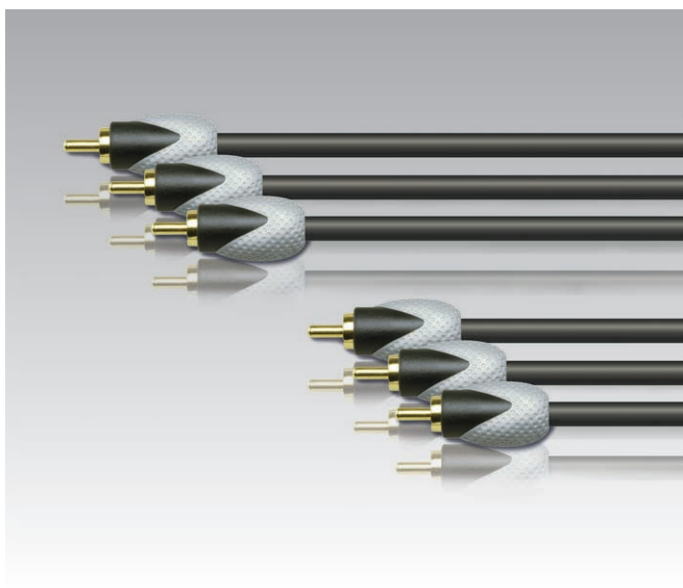

YUV-Verbindung

3x Cinch-Stecker – 3x Cinch-Stecker

- Ergonomisches, exklusives Steckerdesign
- Mit Schirmung – zur Vermeidung äußerer Störstrahlung
- Vergütete Kontaktflächen – beugt Korrosion vor
- Analoge Verbindung von DVD-Receiver mit Farbkomponenten-Ausgang (YUV) an Plasma-/LCD-TV, Projektoren, usw.
- YUV (Component Video – getrennte, hochwertige Video-Signalübertragung der Grundfarben Rot, Grün und Blau). Optimal für z.B. Plasma-/LCD-TV, Projektoren, usw.

YUV connector

3x Cinch plug – 3x Cinch plug

- Ergonomic, exclusive plug design
- Shielded – to prevent external interference radiation
- Tempered contact surfaces – to prevent corrosion
- Analogue connection of DVD receiver with colour component output (YUV) to plasma/LCD TVs, projectors, etc.. Gold plated Cinch plug with colour coding (red/green/blue).
- YUV (component video – separate, high-quality video signal transmission of the basic colours red, green and blue). Ideal for plasma/LCD TVs, projectors, etc

EAN	Art.-Nr. item-no.	Länge length	DIY	VPE QTY
40009530	2966 6	1,5m	-	4

LAUTSPRECHER

Loudspeaker



Lautsprecher-Kabel

transparent, auf Mini-Spule

Loudspeaker cable

transparent, on mini coil

EAN	Art.-Nr. item-no.	Länge length	Ø	DIY	VPE QTY
4000953	22956 1	10,0m	2x 2,5mm ²	•	6
4000953	22953 0	10,0m	2x 1,5mm ²	•	6
4000953	22952 3	20,0m	2x 0,75mm ²	•	6
4000953	23245 5	10,0m	2x 0,5mm ²	•	12

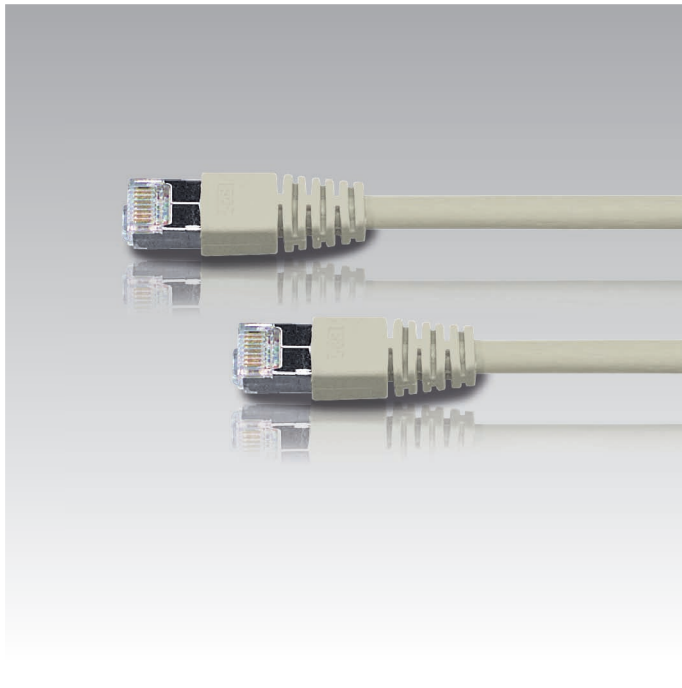

Netzwerk-kabel

2x RJ45 für Ethernet 10BaseT, CAT 5 Patchkabel.
Parallel beschaltet mit Gesamtabschirmung. Zur Verbindung vom Computer zum Hub.

Network cable

2x RJ45 for Ethernet 10BaseT, CAT 5 Patch cable.
Parallel wiring with total screening. For connecting computer to hub.

EAN	Art. -Nr. item-no.	Länge length	DIY	VPE QTY
40009530	8510 5	1,0m	-	8
40009530	8511 2	2,0m	-	8
40009530	8512 9	3,0m	-	8
40009530	8513 6	5,0m	-	8
40009530	8514 3	10,0m	-	6
40009530	8522 8	15,0m	-	4
40009530	8221 0	4,0m	•	30
40009530	8223 4	12,0m	•	20
40009530	8224 1	20,0m	•	10
40009530	8225 8	30,0m	•	7

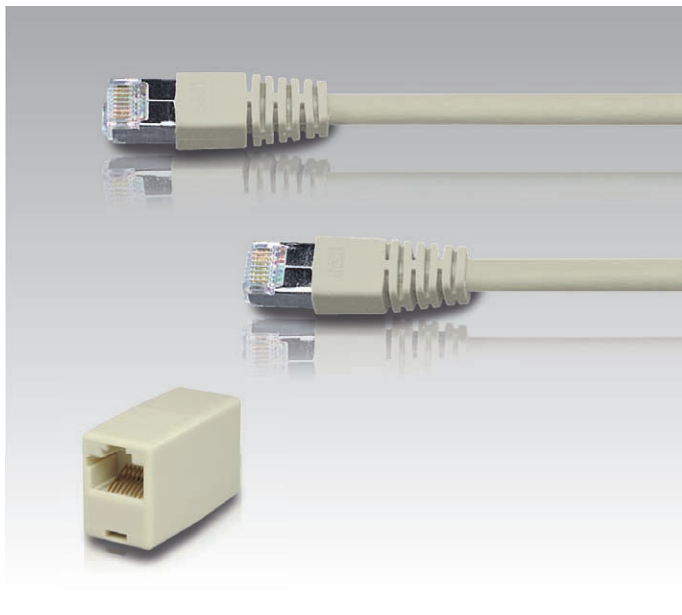

Netzwerk-kabel

2x RJ45 für Ethernet + Cross Over Adapter.
Cat 5 Patchkabel zur direkten Verbindung zweier Computer.
Der beiliegende 8p8c (RJ45) Adapter ermöglicht das Adaptieren eines 1:1 belegten Patchkabels zu einem Cross Over Kabel.

Network cable

2x RJ45 for Ethernet + crossover adapter.
Cat 5 patch cable for directly connecting two computers. The enclosed 8p8c (RJ45) adapter enables the adaptation of one 1:1 allocated patch cable to a crossover cable.

EAN	Art. -Nr. item-no.	Länge length	DIY	VPE QTY
40009530	8126 8	5,0m	-	8
40009530	8128 2	10,0m	-	6

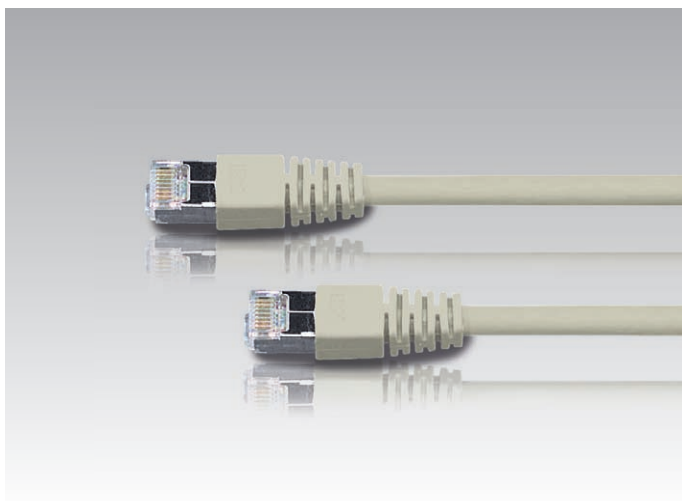

DSL/ CAT 5 Netzwerk-kabel, parallel

Stecker RJ45 – Stecker RJ45 (8p8c)
DSL Verbindungskabel. Zur Verbindung von PC/ Notebooks an Splitter/ Modems/ CAT5 Anschlussdosen oder zwischen Splitter und Modem.

DSL/ CAT 5 network cable, parallel

RJ45 plug – RJ45 (8p8c) plug
DSL connection cable. To connect PCs/notebooks to filters/modems/CAT5 connection sockets or to connect between the filter and the modem.

EAN	Art. -Nr. item-no.	Länge length	DIY	VPE QTY
40009530	7156 6	5,0m	-	8
40009530	7157 3	10,0m	-	6

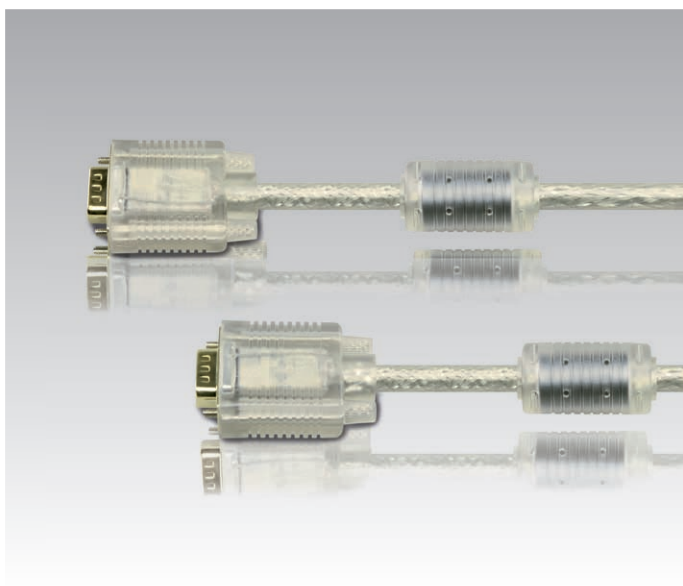

Premium SVGA Monitorkabel

Hochwertiges, geschirmtes, transparentes Kabelmaterial mit vergoldeten 15 poligen HD Steckern für optimale Bildübertragung bei extremen Bedingungen.

- Mit Ferritkernen gegen Störeinflüsse
- Einzeln geschirmte 75 Ohm Video-Leitung (3x RGB, Coax)
- Doppelte Gesamtschirmung
- Optimaler Knickschutz

Premium SVGA Monitor Cable

High-quality, shielded, transparent cable material with gold plated 15-pole HD connectors for optimum picture transmission in extreme conditions.

- With ferrite cores against interferences
- Individually shielded 75 Ohm video cable (3x RGB, Coax)
- Double-shielded
- Optimum bend protection

EAN	Art. -Nr. item-no.	Länge length	DIY	VPE QTY
40009530	8014 8	2,0m	-	6

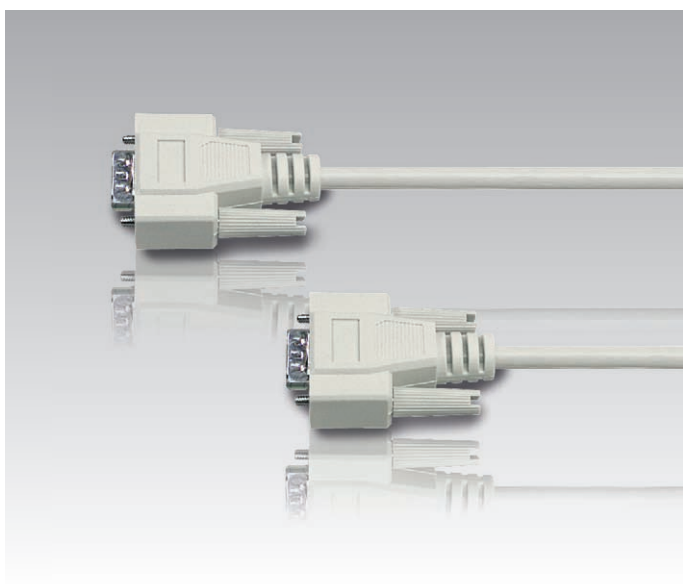

Monitoranschlusskabel

15p HDD Stecker – 15p HDD Stecker

- 15 polig beschaltet
- vergossenes Gehäuse
- Die Abschirmung garantiert eine sichere Übertragung
- Für Auflösungen bis 1024 x 768p

Monitor connection cable

15p HDD plug – 15p HDD plug

- 15 pin switching
- Cast housing
- The screening guarantees secure communication
- For resolutions up to 1024 x 768p

EAN	Art. -Nr. item-no.	Länge length	DIY	VPE QTY
4000953	81151 3	2,5m	-	6
40009530	8113 8	5,0m	-	6

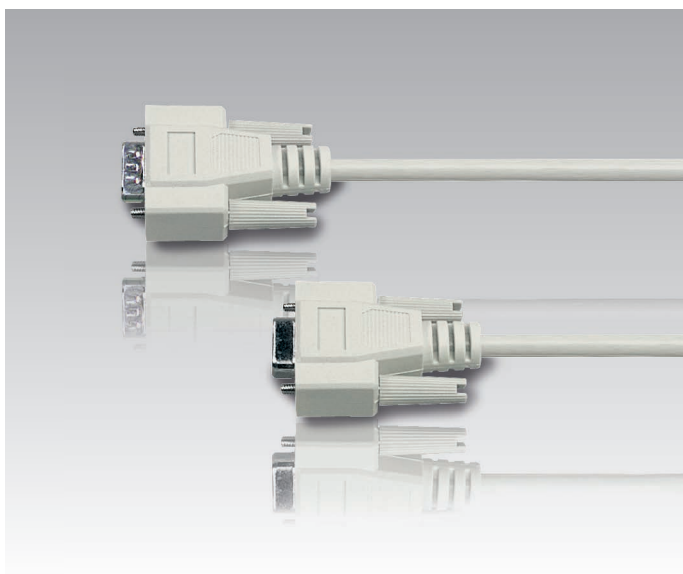

Monitorverlängerung

15p HDD Stecker – 15p HDD Kupplung

15-polig beschaltet, vergossenes Gehäuse.
Empfohlen für Auflösungen bis 1024 x 768 pixel.

Extension monitor cable

15p HDD plug – 15p HDD connector

15-pin connection, encapsulated housing.
Recommended for resolutions up to 1024 x 768 pixel.

EAN	Art. -Nr. item-no.	Länge length	DIY	VPE QTY
4000953	81101 8	3,0m	-	6



„Profi“ ISDN Telefon-Installationskabel

Abgeschirmtes Rundkabel, 8-adrig, 4 x 2 x 0,6mm Ø J-Y(St)Y.
8-adriges, geschirmtes Telefon-Rundkabel für die Installation von ISDN- und Telefon-Anschlussdosen, Nebenstellen- oder Gegensprechanlagen.

“Professional” ISDN telephone installation cable

Shielded round cable 8-core, 4 x 2 x 0.6mm Ø J-Y(St)Y
8-core, shielded round telephone cable for installing ISDN and telephone connection boxes, extensions or intercom systems.

EAN	Art.-Nr. item-no.	Länge length	DIY	VPE QTY
40009530	7007 1	25,0m	-	4
40009530	7008 8	50,0m	-	4



„Profi“ Telefon-Installationskabel

Abgeschirmtes Rundkabel 4-adrig, 2 x 2 x 0,6mm Ø

“Professional” telephone installation cable

Shielded round cable 4-core, 2 x 2 x 0.6 mm Ø

EAN	Art.-Nr. item-no.	Länge length	DIY	VPE QTY
40009530	7013 2	10,0m	•	10
40009530	7014 9	15,0m	•	12
40009530	7016 3	25,0m	•	4



DSL-Modem-Anschlusskabel

RJ45-Stecker – RJ11-Stecker
2-adriges Anschlusskabel zwischen DSL-Modem und DSL-Splitter mit RJ11-Buchse.

DSL modem connecting cable

RJ45 plug – RJ11 plug
2-wire connecting cable between DSL modem and DSL splitter with RJ11 socket.

EAN	Art.-Nr. item-no.	Länge length	DIY	VPE QTY
40009530	7291 4	3,0m	-	6
40009530	7171 9	6,0m	-	4



DSL-PC-Anschlusskabel

RJ45-Stecker – RJ45-Stecker
4-adriges Anschlusskabel zwischen PC-Netzwerkkarte und DSL-Modem.

DSL PC connecting cable

RJ45 plug – RJ45 plug
4-wire connecting cable between PC network card and DSL modem.

EAN	Art.-Nr. item-no.	Länge length	DIY	VPE QTY
40009530	7176 4	6,0m	-	4

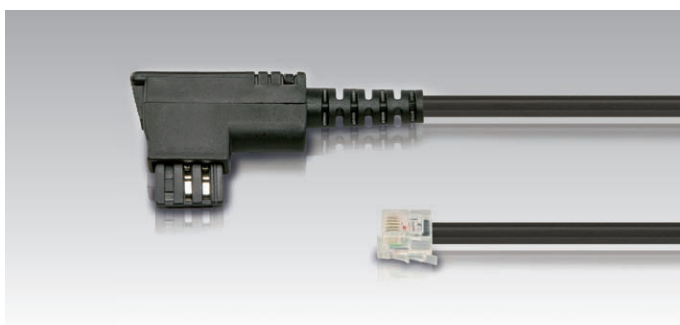

DSL-Splitter-Anschlusskabel

RJ12-Stecker (seitliche Rastnase) – TAE F-Stecker
2-adriges Anschlusskabel zwischen DSL-Splitter und TAE F-Dose.

DSL splitter connecting cable

RJ12 plug (lateral catch) – TAE F plug
2-wire connecting cable between DSL splitter and TAE F box.

EAN	Art.-Nr. item-no.	Länge length	DIY	VPE QTY
40009530	7193 1	3,0m	-	6
40009530	7191 7	6,0m	-	4
40009530	7192 4	10,0m	-	4



ISDN Telefon-/Zusatzgeräte-Anschlusskabel

RJ45-Stecker – RJ45-Stecker.

4-adrig verschaltetes ISDN-Anschlusskabel für ISDN Telefone und Zusatzgeräte.

ISDN Telephone/accessory cable

RJ45 plug – RJ45 plug.

4-core fully-wired ISDN connecting cable for ISDN telephones and accessories.

EAN	Art.-Nr. item-no.	Länge length	DIY	VPE QTY
40009530	7183 2	3,0m	–	6
40009530	7184 9	6,0m	–	6
40009530	7081 1	10,0m	–	4
4000953	27081 5	10,0m	•	12



ISDN-Verlängerungskabel

RJ45-Stecker – RJ45-Buchse.

4-adriges Verlängerungskabel für ISDN-Zusatzgeräte und Telefone.

ISDN extension cable

RJ45 plug – RJ45 socket.

4-core extension cable for ISDN accessories and telephones.

EAN	Art.-Nr. item-no.	Länge length	DIY	VPE QTY
40009530	7088 0	10,0m	–	6
4000953	27088 4	10,0m	•	10



Telefon-Anschlusskabel

TAE F-Stecker – RJ11-Stecker

2-adriges Anschlusskabel

Universal für 2-polige Telefone, z.B. Siemens + Telekom

Telephone Connection Cable

TAE F plug – RJ11 plug

2-core connection cable

Universal for 2-pole telephones, e.g. Siemens + Telekom

EAN	Art.-Nr. item-no.	Länge length	DIY	VPE QTY
40009530	7030 9	3,0m	–	6
40009530	7031 6	6,0m	–	4



Telefon-/Zusatzgeräte-Anschlusskabel

RJ11-Stecker – RJ11-Stecker.

4-adriges Anschlusskabel für Zusatzgeräte und Telefone an Western-Anschlussdosen.

Cable for telephones/ancillary equipment

RJ11-plug – RJ11-plug.

4-core cable for connecting ancillary equipment and telephones to Western connection boxes.

EAN	Art.-Nr. item-no.	Länge length	DIY	VPE QTY
40009530	7186 3	3,0m	–	6
40009530	7187 0	6,0m	–	4

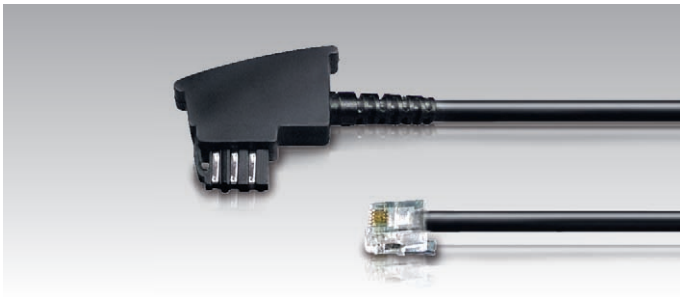

Zusatzgeräte-Anschlusskabel

TAEN N-Stecker – RJ11-Stecker

2-adriges Anschlusskabel für Zusatzgeräte.

Accessory cable

TAEN plug – RJ11 plug

2-core connecting cable for accessories.

EAN	Art.-Nr. item-no.	Länge length	DIY	VPE QTY
40009530	7046 0	10,0m	–	4
4000953	27046 4	10,0m	•	12

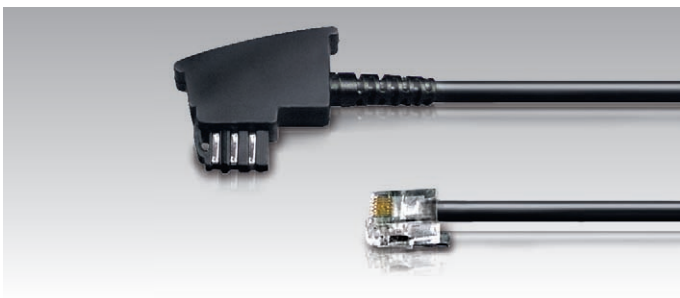

Zusatzgeräte-Anschlusskabel

TAEN-Stecker – RJ12-Stecker

Vollverschaltetes Anschlusskabel für Zusatzgeräte mit automatischer Signalführung.

Accessory cable

TAEN plug – RJ12 plug

Fully-wired connecting cable for accessories with automatic signal feedback.

EAN	Art.-Nr. item-no.	Länge length	DIY	VPE QTY
40009530	7027 9	10,0m	–	4

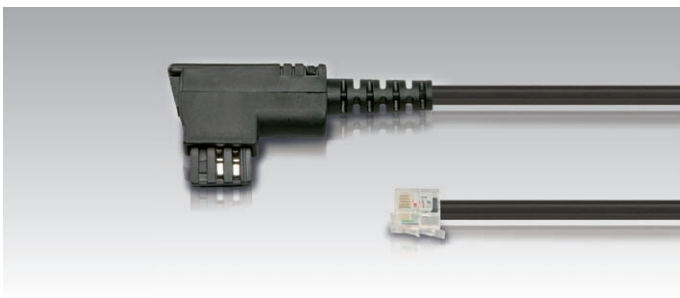

Zusatzgeräte-Anschlusskabel

TAEN-Stecker – RJ11-Stecker

2-adriges Anschlusskabel für Zusatzgeräte.

Accessory cable

TAEN plug – RJ11 plug

2-core connecting cable for accessories.

EAN	Art.-Nr. item-no.	Länge length	DIY	VPE QTY
40009530	7265 5	3,0m	–	6
40009530	7266 2	6,0m	–	6



Telefon-/Zusatzgeräte-Verlängerungskabel

RJ11-Stecker – RJ11-Buchse.

4-adriges Verlängerungskabel für Zusatzgeräte und Telefone.

Extension cable for telephones / ancillary equipment

RJ11-plug – RJ11-jack.

4-core extension cable for connecting ancillary equipment and telephones.

EAN	Art.-Nr. item-no.	Länge length	DIY	VPE QTY
40009530	7132 0	3,0m	–	6
40009530	7057 6	6,0m	–	6
40009530	7068 2	10,0m	–	4



Universal Telefon-Anschluss-Set

3 TAE F-Adapter, RJ11-Stecker – RJ11-Stecker.

Durch Adaptertausch lässt sich das Kabel für alle handelsüblichen Telefone konfigurieren.

Universal telephone connector set

3 TAE F adapters, RJ11 plug – RJ11 plug.

The cable can be configured for all commonly available telephones by changing the adapter.

EAN	Art.-Nr. item-no.	Länge length	DIY	VPE QTY
40009530	7252 5	3,0m	–	6
40009530	7253 2	6,0m	–	4
40009530	7091 0	10,0m	–	4
40009530	7092 7	15,0m	–	4



Universal Zusatzgeräte-Anschluss-Set

2 TAE N-Adapter, RJ11-Stecker – RJ11-Stecker.

Durch Adaptertausch lässt sich das Kabel für alle handelsüblichen Zusatzgeräte konfigurieren.

Universal accessory connector set

2 TAE N adapters, RJ11 plug – RJ11 plug.

The cable can be configured for all commonly available accessories by changing the adapter.

EAN	Art. -Nr. item-no.	Länge length	DIY	VPE QTY
40009530	7263 1	3,0m	-	6
40009530	7096 5	10,0m	-	4



Telefon-Verlängerungskabel

TAE F-Stecker – TAE F-Buchse.

4-adriges Verlängerungskabel für Telefone.

Telephone extension cable

TAE F plug – TAE F socket.

4-core extension cable for telephones.

EAN	Art. -Nr. item-no.	Länge length	DIY	VPE QTY
4000953	27070 9	10,0m	•	10



Zusatzgeräte-Verlängerungskabel

TAE N-Stecker – TAE N-Buchse.

6-adriges Verlängerungskabel für Zusatzgeräte.

Accessory extension cable

TAE N plug – TAE N socket.

6-core extension cable for accessories.

EAN	Art. -Nr. item-no.	Länge length	DIY	VPE QTY
4000953	27072 3	10,0m	•	10



TAE-Verlängerung Universal

TAE U-Stecker – TAE U-Buchse Universal

6-adriges Verlängerungskabel (zum Verlängern von TAE F- und TAE N-Kabeln) für Telefone und Zusatzgeräte.

Universal TAE extension

Universal TAE U-plug – TAE U-socket

6-wire extension cable (for extending TAE F and TAE N cables) for telephones and auxiliaries.

EAN	Art. -Nr. item-no.	Länge length	DIY	VPE QTY
40009530	7162 7	1,0m	-	6
40009530	7163 4	3,0m	-	6
40009530	7164 1	6,0m	-	4
40009530	7165 8	10,0m	-	1



Telefonhörer-Anschlusskabel

RJ10-Stecker – RJ10-Stecker.

4-adrig verschaltetes Spiralkabel zum Verbinden von Telefon und Hörer.

Telephone receiver cable

RJ10 plug – RJ10 plug.

4-core fully-wired spiral cable for connecting the telephone and the receiver.

EAN	Art. -Nr. item-no.	Länge length	DIY	VPE QTY
40009530	7036 1	3,0m	-	4



ISDN Kabeltrommel

Zum Verlängern eines ISDN-Anschlusses

Ermöglicht den Anschluss von zwei ISDN-Geräten

- 4-adrig verschaltetes ISDN Anschlusskabel mit RJ45 Stecker
- RJ45 Stecker – 2x RJ45-Buchsen

ISDN cable reel

For extending an ISDN connection.

Enables the connection of two ISDN devices

- 4-wire connected ISDN connection cable with RJ45 plug
- RJ45 plug – 2x RJ45 socket

EAN	Art.-Nr. item-no.	Länge length	DIY	VPE QTY
40009530	7392 8	10,0m	–	6

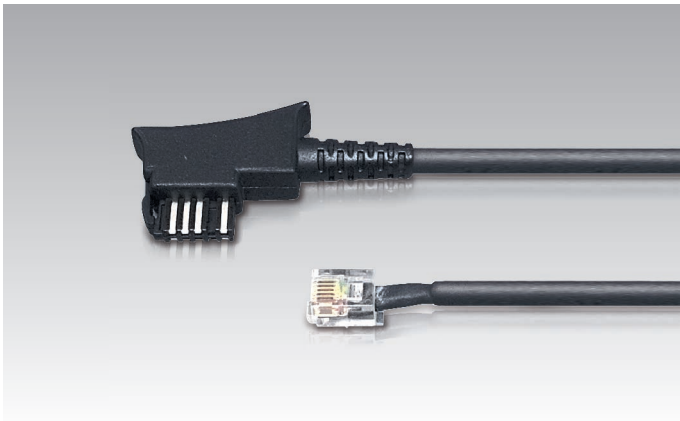

Telefon-/Zusatzgeräte-Anschlusskabel

TSS-Stecker – RJ11-Stecker

6-adriges Anschlusskabel für Telefone, Zusatzgeräte und Telefonanlagen.

Telephone/Accessory cable

TSS plug – RJ11 plug

6-core cable for telephones, accessories and telephone systems.

EAN	Art.-Nr. item-no.	Länge length	DIY	VPE QTY
40009530	7471 0	6,0m	–	10
40009530	7472 7	10,0m	–	6
40009530	7473 4	15,0m	–	6



Netzkabel, Euro

Zum Anschluss von Radios, Kassetten-Abspielgeräte usw. an das Stromnetz.

Mains cable, Euro

For connection of radios, cassette players etc. to the mains supply.

EAN	Art.-Nr. item-no.	Länge length	DIY	VPE QTY
40009530	3100 3	1,5m	-	6

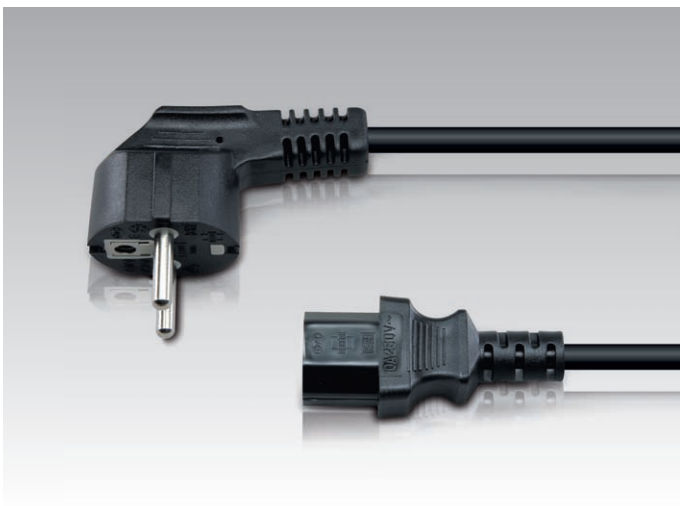

Netzkabel mit Kaltgerätestecker

Zum Anschluss von Computern, Druckern, Kopierern usw. an das Stromnetz.

Power cable with inlet connector for non-heating apparatus

For connection of computers, printers, copiers etc. to the mains supply.

EAN	Art.-Nr. item-no.	Länge length	DIY	VPE QTY
40009530	8411 5	2,0m	-	4



Universal-Schaltnetzteil 600mA

Hocheffizientes Netzgerät im „Öko-Design“

- Kompaktes, modernes Schaltnetzteil inkl. 6 Adapter
- Hohe Energieeffizienz = Kosteneinsparung
- Mit Weitbereichseingang für Netzspannungen von 100-240V
- Eingebauter Kurzschlusschutz und automatischer Überlastschutz
- Nur für den Innengebrauch
- Eingangsspannung: 100-240V ~ 50/60Hz, 10W (max.)
- Ausgangsspannung: 3 / 4,5 / 5 / 6 / 7,5 / 9 / 12VDC, 7,2VA (max.)
- Ausgangsstrom: 600mA

Universal 600mA switched mains unit

High efficiency mains unit in "eco-design"

- Compact, modern switched mains unit including 6 adapters
- High efficiency = cost savings
- Wide input range for mains voltages from 100-240V
- Built in short-circuit protection and automatic overload protection
- Only for indoor use
- Input voltage: 100-240V ~ 50/60Hz, 10W (max.)
- Output voltage: 3 / 4.5 / 5 / 6 / 7.5 / 9 / 12VDC, 7.2VA (max.)
- Output current: 600mA

EAN	Art.-Nr. item-no.	Länge length	DIY	VPE QTY
40009530	3444 8	-	-	1



Stecker

Plug

F-Stecker
 Antenne
 HDMI/DVI
 USB
 Cinch/Klinke
 Scart
 Video
 Netzwerk
 Lautsprecher
 Telefon

F plug 42
 Antenna 45
 HDMI/DVI 48
 USB 49
 Phono/Jack 50
 Scart 52
 Video 53
 Network 53
 Loudspeaker 53
 Telephone 54

F-STECKER

F PLUG



F-Stecker, für Koaxial-Kabel Ø 7mm

Hochwertigste Verbindung von Satelliten- und Antennenkomponenten

F plug for coaxial cable Ø 7mm

Highest quality connection of satellites and aerial components

EAN	Art.-Nr. item-no.	Anzahl pieces	DIY	VPE QTY
40009530	3847 7	4	-	10

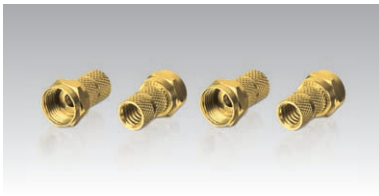

F-Stecker, für Koaxial-Kabel Ø 6mm

Hochwertigste Verbindung von Satelliten und Antennenkomponenten

F plug for coaxial cable Ø 6mm

Highest quality connection of satellites and aerial components

EAN	Art.-Nr. item-no.	Anzahl pieces	DIY	VPE QTY
40009530	3846 0	4	-	10



F-Stecker, eloxiert

Optimierte Oberflächenveredlung schützt vor Störungen

F Plug, anodised

Optimised surface finish protects against interferences

EAN	Art.-Nr. item-no.	Anzahl pieces	DIY	VPE QTY
40009530	3646 6	2	-	10



F-Stecker für Koaxial-Kabel Ø 8mm

Ideal für 4-fach geschirmte Koaxial-Kabel

F-plug for Ø 8mm coaxial cable

Ideal for quad-shield coaxial cable

EAN	Art.-Nr. item-no.	Anzahl Pieces	DIY	VPE QTY
40009530	3880 4	4	-	10
40009530	3881 1	8	-	10



F-Stecker, für Koaxial-Kabel Ø 7mm

Zur Verbindung von Satellitenkomponenten

F plug, for coaxial cable Ø 7mm

For connecting satellite components

EAN	Art.-Nr. item-no.	Anzahl Pieces	DIY	VPE QTY
40009530	3546 9	2	-	10
4000953	35465 2	5	-	10
4000953	35461 4	10	-	10
4000953	23546 3	2	•	100



F-Stecker, für Koaxial-Kabel Ø 6mm

Zur Verbindung von Satellitenkomponenten

F plug, for coaxial cable Ø 6mm

For connecting satellite components

EAN	Art.-Nr. item-no.	Anzahl Pieces	DIY	VPE QTY
40009530	3547 6	2	-	10
40009530	3584 1	10	-	10
4000953	23547 0	2	•	100
4000953	23584 5	10	•	50

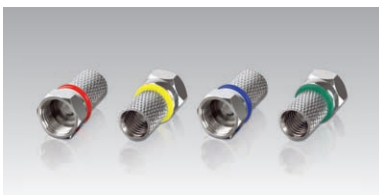

F-Stecker mit Farbcodierung

Für Koaxial-Kabel Ø 7 mm, erleichtert Montage und Übersicht

F plug with color coding

For coaxial cable Ø 7mm

EAN	Art.-Nr. item-no.	Anzahl Pieces	DIY	VPE QTY
40009530	3682 4	4	-	10
40009530	3680 1	8	-	10





F-Verbinder
Zur Verbindung von F-Gold-Anschlusskabeln

F connector
For connecting F gold cables

EAN	Art.-Nr. item-no.	Länge length	DIY	VPE QTY
40009530	3681 7	-	-	10



F-Verbinder
Zur Verbindung von F-Anschlusskabeln

F connector
For connecting F cables

EAN	Art.-Nr. item-no.	Länge length	DIY	VPE QTY
40009530	3567 4	-	-	10



F-Verbinder
Zur Verbindung von F-Anschlusskabeln

F connector
For connecting F cables

EAN	Art.-Nr. item-no.	Länge length	DIY	VPE QTY
40009530	3687 9	-	-	10



F-Winkeladapter
Optimierte Kabelführung bei Satelliten und Antennenkomponenten

F angle adapter
Optimised cable routing for satellites and aerial components

EAN	Art.-Nr. item-no.	Länge length	DIY	VPE QTY
40009530	3565 0	-	-	10



F-Adapter, F-Stecker – Koaxial-Kupplung
Wandelt einen Koaxial-Stecker in einen F-Stecker!

F Adapter, F Plug – Coaxial Connector
Converts a coaxial plug into an F plug!

EAN	Art.-Nr. item-no.	Länge length	DIY	VPE QTY
40009530	3564 3	-	-	10



F-Adapter, F-Stecker – Koaxial-Stecker
Wandelt eine Koaxial-Kupplung in einen F-Stecker!

F Adapter, F Plug – Coaxial Plug
Converts a coaxial connector into an F plug!

EAN	Art.-Nr. item-no.	Länge length	DIY	VPE QTY
40009530	3571 1	-	-	10



F-Adapter, F-Kupplung – Koaxial-Kupplung
Wandelt einen F-Stecker in eine Koaxial-Kupplung!

F Adapter, F Connector – Coaxial Connector
Converts an F plug into a coaxial connector!

EAN	Art.-Nr. item-no.	Länge length	DIY	VPE QTY
40009530	3572 8	-	-	10



F-Adapter, F-Kupplung – Koaxial-Stecker
Wandelt einen F-Stecker in einen Koaxial-Stecker!

F Adapter, F Connector – Coaxial Plug
Converts an F plug into a coaxial plug!

EAN	Art.-Nr. item-no.	Länge length	DIY	VPE QTY
40009530	3573 5	-	-	10

F-STECKER

F PLUG



Wetterschutztülle für F-Stecker

Langlebige Gummitülle vermeidet Korrosion durch Spritzwasser am F-Stecker

Weatherproof bush for F plugs

Long-life rubber bush prevents corrosion of the F plug due to spray water

EAN	Art.-Nr. item-no.	Länge length	DIY	VPE QTY
40009530	3666 4	-	-	10



Wetterschutztülle für F-Stecker

Langlebige Gummitülle vermeidet Korrosion durch Spritzwasser am F-Stecker

Weatherproof bush for F plugs

Long-life rubber bush prevents corrosion of the F plug due to spray water

EAN	Art.-Nr. item-no.	Länge length	DIY	VPE QTY
40009530	3666 7	-	-	10



F-Wetterschutzset SINGLE

2x F-Stecker (Ø 7mm) + 1x weiße Tülle

Schützt F-Verbindungen vor Feuchtigkeit und Schlagregen

Weather Proof F Set SINGLE

2x F plug (Ø 7mm) + 1x white rubber bush

Protects F connections against dampness and driving rain

EAN	Art.-Nr. item-no.	Länge length	DIY	VPE QTY
40009530	3684 8	-	-	10



F-Wetterschutzset QUAD

- Schützt F-Verbindungen vor Feuchtigkeit und Schlagregen.
- Vermeidet Kurzschlüsse und Receiverschäden durch eindringende Feuchtigkeit.
- UV-beständige, weiße Gummitülle mit neuartiger Gummimischung für langlebigen Schutz der F-Verbindung.

Weather Proof F Set QUAD

- Protects F connections against dampness and driving rain.
- Prevents short circuits and damage to the receiver caused by penetrating moisture.
- UV-resistant, white rubber bushing with new rubber compound for long-lasting F connection protection.

EAN	Art.-Nr. item-no.	Länge length	DIY	VPE QTY
40009530	3683 1	-	-	10



Antennen-Kupplung

Hochwertige Metallausführung, vollgeschirmt

Aerial coupling

High-quality metal design, fully screened

EAN	Art.-Nr. item-no.	Länge length	DIY	VPE QTY
40009530	3654 1	-	-	10



Antennen-Stecker

Hochwertige Metallausführung, vollgeschirmt

Aerial plug

High-quality metal design, fully screened

EAN	Art.-Nr. item-no.	Länge length	DIY	VPE QTY
40009530	3655 8	-	-	10



Antennen-Stecker Set

Hochwertige Metallausführung zur Erstellung von Antennenkabeln

Aerial plug set

High-quality metal design for making up aerial cables

EAN	Art.-Nr. item-no.	Länge length	DIY	VPE QTY
40009530	3659 6	-	-	10



Koaxial-Kabelverbinder

Hochwertige Metallausführung – Empfohlen für Digital TV (DVB) von Sat, Antenne und Kabelfernsehen

Coaxial cable connector

High-quality metal design – Recommended for digital TV (DVB) from satellite, aerial and cable television

EAN	Art.-Nr. item-no.	Länge length	DIY	VPE QTY
40009530	3613 8	-	-	10



Zweigeräteverteiler TV

Hochwertige Metallausführung, vollgeschirmt
Zum Anschluss von 2 Fernsehgeräten an einen Antennenanschluss

Distributor for two devices TV

High quality metal design, fully screened
For connecting 2 television sets to one aerial connector

EAN	Art.-Nr. item-no.	Länge length	DIY	VPE QTY
40009530	3586 5	-	-	10



Zweigeräteverteiler Radio

Hochwertige Metallausführung, vollgeschirmt
Zum Anschluss von 2 Radiogeräten an einen Antennenanschluss

Distributor for two devices radio

High quality metal design, fully screened
For connecting 2 radio sets to one aerial connector

EAN	Art.-Nr. item-no.	Länge length	DIY	VPE QTY
40009530	3587 2	-	-	10



Antennen-Kupplung
Kunststoffausführung, weiß
Aerial coupling
Plastic design, white

EAN	Art.-Nr. item-no.	Länge length	DIY	VPE QTY
40009530	3554 4	-	-	10
4000953	23554 8	-	•	80



Antennen-Stecker
Kunststoffausführung, weiß
Aerial plug
Plastic design, white

EAN	Art.-Nr. item-no.	Länge length	DIY	VPE QTY
40009530	3555 1	-	-	10
4000953	23555 5	-	•	60



Antennen-Kupplung
Kunststoffausführung, schwarz
Aerial coupling
Plastic design, black

EAN	Art.-Nr. item-no.	Länge length	DIY	VPE QTY
40009530	3548 3	-	-	10



Antennen-Stecker
Kunststoffausführung, schwarz
Aerial plug
Plastic design, black

EAN	Art.-Nr. item-no.	Länge length	DIY	VPE QTY
40009530	3549 0	-	-	10



Antennen-Winkelkupplung
Optimierte Koaxialkabelführung durch 90° Anschluss
Aerial angle coupling
Optimised coaxial cable routing due to 90° connector

EAN	Art.-Nr. item-no.	Länge length	DIY	VPE QTY
40009530	3312 0	-	-	10



Antennen-Winkelstecker
Optimierte Koaxialkabelführung durch 90° Anschluss
Aerial angle plug
Optimised coaxial cable routing due to 90° connector

EAN	Art.-Nr. item-no.	Länge length	DIY	VPE QTY
40009530	3311 3	-	-	10



Koaxial-Kabelverbinder
Zum Verbinden zweier Koaxial-Kabel gleicher oder unterschiedlicher Durchmesser
Coaxial cable connector
For connecting two coaxial cables of the same or different diameter

EAN	Art.-Nr. item-no.	Länge length	DIY	VPE QTY
40009530	3313 7	-	-	10



Zweigeräteverteiler TV

Kunststoffausführung, weiß

Zum Anschluss von 2 TV-Geräten an einen Antennenanschluss

Distributor for two devices TV

Plastic design, white

For connecting 2 TV sets to one aerial connector

EAN	Art.-Nr. item-no.	Länge length	DIY	VPE QTY
40009530	3526	1	-	10
4000953	23526	5	-	60



Zweigeräteverteiler RF

Kunststoffausführung, weiß

Zum Anschluss von 2 Radiogeräten an einen Antennenanschluss

Distributor for two devices RF

Plastic design, white

For connecting 2 radio sets to one aerial connector

EAN	Art.-Nr. item-no.	Länge length	DIY	VPE QTY
40009530	3527	8	-	10



Koaxialverbinder-Set

Stecker – Stecker/Kupplung – Kupplung

Coaxial Cable Connector Set

Plug – Plug / Inline Socket – Inline Socket

EAN	Art.-Nr. item-no.	Länge length	DIY	VPE QTY
40009530	3558	2	-	10



Koaxial-Stecker Set, weiß

Zur Erstellung von Antennenanschlusskabel

Coaxial plug set, white

For producing aerial connecting cable

EAN	Art.-Nr. item-no.	Länge length	DIY	VPE QTY
40009530	3559	9	-	10



Antennen-Winkelstecker Set

Optimierte Koaxialkabelführung durch 90° Anschluss

Aerial angle plug set

Optimised coaxial cable routing due to 90° connector

EAN	Art.-Nr. item-no.	Länge length	DIY	VPE QTY
40009530	3553	7	-	10



Zweifach-Verteiler

Verbindet Zusatzgeräte und Antenne an einen TV-Geräteingang

Two-way distributor

Connects additional devices and aerial to one TV device input

EAN	Art.-Nr. item-no.	Länge length	DIY	VPE QTY
40009530	3514	8	-	4



HDMI-Rotations-Adapter, vergoldet

HDMI-Rotations-Stecker – HDMI-Kupplung

- Drehbarer Rotations-Stecker (zwei Drehachsen)
- Flexibler Einsatz bei beengten Platzverhältnissen (z.B. zwischen TV und Wand)
- Unterstützt hochauflösendes Full-HDTV
- Vergütete Kontaktflächen

Rotating HDMI Adapter, gold-plated

Rotating HDMI Plug – HDMI Connector

- Rotating plug (two rotation axes)
- For use in confined spaces (e.g. between TV and wall)
- Supports high resolution Full HDTV
- Coated contact surfaces

EAN	Art.-Nr. item-no.	Länge length	DIY	VPE QTY
40009530	3209 3	-	-	10



HDMI-Micro-Adapter, vergoldet

Zur Adaptierung von HDMI (Typ A) auf HDMI-Micro (Typ D)

- Unterstützt hochauflösendes Full-HDTV
- Vergütete Kontaktflächen

HDMI Micro-Adapter, gold-plated

To convert from HDMI (Type A) to HDMI Micro (Type D)

- Supports high resolution Full HDTV
- Coated contact surfaces

EAN	Art.-Nr. item-no.	Länge length	DIY	VPE QTY
40009530	3213 0	-	-	10



HDMI-Kupplung, vergoldet

Kupplung zum Verbinden/Verlängern von zwei HDMI-Kabeln (A-Stecker)

HDMI coupler, gold plated

Coupler for connecting/extending two HDMI cables (type A male)

EAN	Art.-Nr. item-no.	Länge length	DIY	VPE QTY
40009530	3227 7	-	-	10



DVI-D/HDMI-Adapter, vergoldet

DVI-D-Stecker – HDMI-Kupplung

- Kompakter Adapter, verbindet DVI-D- und HDMI-Endgeräte
- Ermöglicht den Anschluss von Endgeräten mit DVI-D-Eingang (z.B. Plasma/LCD TV, Beamer) an HDMI-Stecker-Verbindungen/ Ausgänge
- 2 integrierte Schrauben zur stabilen Adaptierung
- Vergoldete Kontaktflächen

DVI-D/HDMI Adapter, gold plated

DVI-D plug – HDMI connector

- Compact adapter, connects DVI-D and HDMI end devices
- Enables the connection of end devices with DVI-D input (e.g. plasma/LCD TV, beamer) to HDMI plug connections/outputs
- 2 integrated screws for robust fixture
- Gold plated contact surfaces

EAN	Art.-Nr. item-no.	Länge length	DIY	VPE QTY
40009530	3249 9	-	-	4



HDMI/DVI-D-Adapter, vergoldet

HDMI-Stecker – DVI-D-Kupplung

- Kompakter Adapter, verbindet HDMI- und DVI-D-Endgeräte
- Ermöglicht den Anschluss von Endgeräten mit HDMI-Eingang (z.B. Plasma/ LCD TV, Beamer) an DVI-D-Steckerverbindungen/ Ausgänge (z.B. DVD-Player, PC)
- 2 integrierte Muttern zur stabilen Adaptierung
- Vergoldete Kontaktflächen

HDMI/DVI-D Adapter, gold plated

HDMI plug – DVI-D connector

- Compact adapter, connects HDMI and DVI-D end devices
- Enables the connection of end devices with HDMI input (e.g. plasma/ LCD TV, beamer) to DVI-D plug connections/outputs (e.g. DVD player, PC)
- 2 integrated nuts for robust fixture

EAN	Art.-Nr. item-no.	Länge length	DIY	VPE QTY
40009530	3251 2	-	-	4



HDMI-Winkeladapter
HDMI-Winkel-Stecker – HDMI-Kupplung
HDMI angled adapter
HDMI angled plug – HDMI connector

EAN	Art.-Nr. item-no.	Länge length	DIY	VPE QTY
40009530	3276	5	-	10



HDMI-Mini-Adapter, vergoldet
Zur Adaptierung von HDMI (Typ A) auf HDMI-Mini (Typ C)
• Unterstützt hochauflösendes Full-HDTV
• Vergütete Kontaktflächen

EAN	Art.-Nr. item-no.	Länge length	DIY	VPE QTY
40009530	3299	4	-	10

HDMI Mini-Adapter, gold-plated
To convert from HDMI (Type A) to HDMI Mini (Type C)
• Supports high resolution Full HDTV
• Coated contact surfaces



2-fach HDMI-Kompaktschalter
• Erweitert HDMI-Eingang am Plasma-/LCD-TV auf 2x HDMI-Eingänge (1x OUT/2x IN) für z.B. DVD, PC, Set-Top-Box, usw.
• Manuelle Quellenauswahl per Wahlschalter
• Auflösung: 1920x1080p

EAN	Art.-Nr. item-no.	Länge length	DIY	VPE QTY
4000953	25262	0	-	1

2-Way HDMI Compact Switch
• Turns HDMI input at a plasma/LCD TV into 2 HDMI inputs (1x OUT/2x IN) for DVD players, PCs, set-top boxes, etc.
• Manual source selection at the push of a button
• Resolution: 1920x1080p



USB Adapter
USB A-Buchse – USB A-Buchse
USB Adapter
USB A-socket – USB A-socket

EAN	Art.-Nr. item-no.	Länge length	DIY	VPE QTY
40009530	8120	6	-	10



USB 2.0 HUB 4 Port
Abwärtskompatibel, d.h. auch für USB 1.1 Systeme geeignet. Unterstützt Plug & Play. Windows 98, ME, 2000, XP, Vista, MAC OS 10.1.2 oder höher.

EAN	Art.-Nr. item-no.	Länge length	DIY	VPE QTY
40009530	8281	4	0,55m	20

USB 2.0 HUB 4 port
Downward compatible, i.e. also suitable for USB 1.1 systems. Supports plug & play. Windows 98, ME, 2000, XP, Vista, MAC OS 10.1.2 or higher.

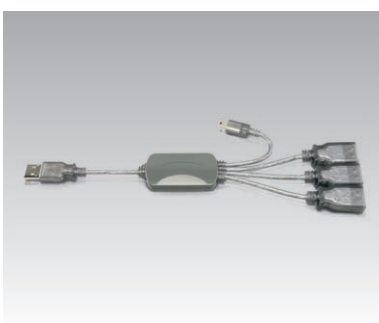

USB 2.0 HUB 3+1 Mini USB B Port, flexibel
Kompakter USB 2.0 HUB mit 3 flexiblen USB A Buchsen (Kupplungen) und 1 flexiblen Mini USB B Stecker (5pin). Ideal für den direkten Anschluss der Geräte mit Mini USB B Stecker, z.B. MP3, Digital Kamera etc. • 1 Upstream und 4 Downstream USB ports

EAN	Art.-Nr. item-no.	Länge length	DIY	VPE QTY
40009530	8284	5	-	10

USB 2.0 HUB 3+1 Mini USB B Port, flexible
Compact USB 2.0 HUB with 3 flexible USB A ports (connectors) and 1 flexible mini USB B connector (5 pin). Ideal for directly connecting devices with mini USB B connector, e.g. MP3 players, digital cameras, etc. • 1 upstream and 4 downstream USB ports



Klinken-Adapter, 3,5mm
1x Klinken-Stecker, 3-polig – 2x Klinken-Kupplung, 3-polig

Jack adapter, 3,5mm
1x jack plug, 3-pole – 2x jack connector, 3-pole

EAN	Art.-Nr. item-no.	Länge length	DIY	VPE QTY
40009530	3140 9	–	–	10



Klinken-Adapter, 3,5mm
1x Klinken-Stecker, 3-polig – 2x Klinken-Kupplung, 3-polig

Jack adapter, 3,5mm
1x jack plug, 3-pole – 2x jack connector, 3-pole

EAN	Art.-Nr. item-no.	Länge length	DIY	VPE QTY
40009530	3383 0	–	–	10



Klinken-Adapter (Doppel-Kupplung), stereo
3,5mm Klinken-Kupplung – 3,5mm Klinken-Kupplung

Jack Adapter (Double Coupler), Stereo
3.5 mm jack connector – 3.5 mm jack connector

EAN	Art.-Nr. item-no.	Länge length	DIY	VPE QTY
40009530	3124 9	–	–	10



Klinken-Adapter, stereo
2,5mm Klinken-Stecker – 3,5mm Klinken-Kupplung

Jack adapter, stereo
2.5mm jack plug – 3.5mm jack line socket

EAN	Art.-Nr. item-no.	Länge length	DIY	VPE QTY
40009530	3112 6	–	–	10



Klinken-Adapter, stereo
2,5 mm Klinken-Stecker – 3,5 mm Klinken-Kupplung
Zur Verbindung von mobilen Endgeräten (z.B. Handy, MP3-Player) mit 3,5mm-Stecker-Verbindungen (z.B. Kopfhörer, Aktivboxen). Mit praktischem Winkelstecker.

Jack Adapter, Stereo
2.5 mm jack plug – 3.5 mm jack connector
For connecting mobile end devices (e.g. mobile phones, MP3 players) to 3.5 mm plug connectors (e.g. headphones, active speakers). With practical right angle plug.

EAN	Art.-Nr. item-no.	Länge length	DIY	VPE QTY
40009530	3104 1	–	–	10



Klinken-Adapter, stereo
3,5mm Klinken-Stecker – 2,5mm Klinken-Kupplung

Jack adapter, stereo
3,5mm jack plug – 2,5mm jack connector

EAN	Art.-Nr. item-no.	Länge length	DIY	VPE QTY
40009530	3111 9	–	–	10



Adapter Cinch – Klinke
2x Cinch-Kupplung – 1x Klinken-Stecker 3,5mm, 3-polig

Jack-Cinch adapter
2x cinch connector – 1x jack plug 3.5mm, 3-pole

EAN	Art.-Nr. item-no.	Länge length	DIY	VPE QTY
40009530	3380 9	–	–	10



Adapter Cinch – Klinke, vergoldet
2x Cinch-Kupplung – 1x Klinken-Stecker 3,5mm, 3-polig

Jack-Cinch adapter, gilded
2x Cinch coupler – jack plug 3.5mm, 3 pole

EAN	Art.-Nr. item-no.	Länge length	DIY	VPE QTY
40009530	3381 6	–	–	10



Klinken-Adapter, stereo, vergoldet

Klinken-Stecker 6,3mm, 3-polig – Klinken-Kupplung 3,5mm, 3-polig

Jack adapter, stereo, gilded

Jack plug 6.3mm, 3-pole – jack connector 3.5mm, 3-pole

EAN	Art.-Nr. item-no.	Länge length	DIY	VPE QTY
40009530	3397 7	-	-	10



Klinken-Adapter, stereo

Klinken-Stecker 6,3mm, 3-polig – Klinken-Kupplung 3,5mm, 3-polig

Jack adapter, stereo

Jack plug 6.3mm, 3-pole – jack connector 3.5mm, 3-pole

EAN	Art.-Nr. item-no.	Länge length	DIY	VPE QTY
40009530	3395 3	-	-	10



Klinken-Adapter, stereo

Klinken-Stecker 3,5mm, 3-polig – Klinken-Kupplung 6,3mm, 3-polig

Jack adapter, stereo

Jack plug 3.5mm, 3-pole – jack connector 6.3mm, 3-pole

EAN	Art.-Nr. item-no.	Länge length	DIY	VPE QTY
40009530	3396 0	-	-	10



Cinch-Adapter

Cinch-Kupplung – Cinch-Kupplung

Phono adapter

Phono connector – phono connector

EAN	Art.-Nr. item-no.	Länge length	DIY	VPE QTY
40009530	3384 7	-	-	10



Klinke-Cinch Adapter

1x 3,5mm Klinke-Kupplung – 2x Cinch-Stecker
Zur Verbindung von Geräten mit 3,5mm Klinken-Stecker-Anschluss (z.B. Kopfhörer) an Cinch-Kupplungen (z.B. Stereoanlage, PC).

Jack-Cinch Adapter

1x3.5 mm jack connector – 2x Cinch plug.
For connecting devices with 3.5 mm jack plug connection (e.g. headphones) to Cinch connector (e.g. stereo system, PC).

EAN	Art.-Nr. item-no.	Länge length	DIY	VPE QTY
40009530	3147 8	-	-	10



Cinch-Adapter

2x Cinch-Kupplungen – 1x Cinch-Stecker.
Zur Verbindung gängiger HiFi, VCR, DVD, etc. Komponenten untereinander.

Cinch Adapter

2x inline Phono sockets – 1x Phono plug.
For connecting common components of HiFi, VCR, DVD, etc to one another.

EAN	Art.-Nr. item-no.	Länge length	DIY	VPE QTY
40009530	3142 3	-	-	10



Cinch-Stecker

Cinch-Stecker zur Selbstmontage

Cinch plugs

Phono plugs for self-assembly

EAN	Art.-Nr. item-no.	Anzahl Pieces	DIY	VPE QTY
40009530	3321 2	2x	-	10



S-VHS Adapterstecker

1x Scart-Stecker – 3x Cinch-Kupplung / S-VHS-Kupplung mit Umschalter

S-VHS adapter plug

1x Scart plug – 3x phono connector / S-VHS connector with selector switch

EAN	Art.-Nr. item-no.	Länge length	DIY	VPE QTY
40009530	2558 3	-	-	4



Scart/Cinch-Adapter

1x Scart-Stecker – 3x Cinch-Kupplung mit Umschalter
Zur Verbindung gängiger HiFi, VCR, DVD, etc. Komponenten untereinander.

Scart/Cinch adapter

1x Scart plug – 3x Cinch line sockets with changeover switch
For the interconnection of common hi-fi, VCR and DVD components etc.

EAN	Art.-Nr. item-no.	Länge length	DIY	VPE QTY
40009530	2557 6	-	-	4



3-fach Scart-Umschalter

- Anschluss von 1-3 Geräten über Scart-Verbindungen an ein TV-Gerät
- Manuelle Videoquellen-Auswahl (z.B. SAT, DVD, VCR)
- Separate Videoquellen-Auswahl vermindert Signalstörung!

3-fold Scart change-over switch

- Connection of 1-3 devices to a TV set via Scart connectors
- Manual selection of video sources (e.g. SAT, DVD, VCR)
- Separate selection of video sources reduces signal interference!

EAN	Art.-Nr. item-no.	Länge length	DIY	VPE QTY
40009530	3247 5	-	-	4

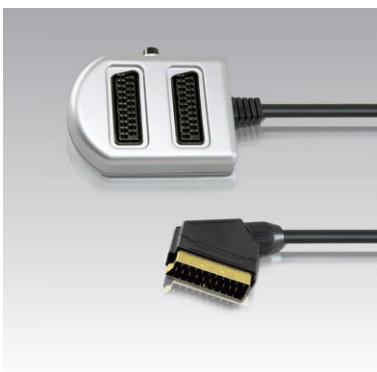

2-fach Scart-Umschalter

- Anschluss von 1-2 Geräten über Scart-Verbindungen an ein TV-Gerät
- Manuelle Videoquellen-Auswahl (z.B. SAT, DVD, VCR)
- Wechselseitige Überspielmöglichkeit (VCR1/VCR2)
- Signalrichtung umschaltbar

2-fold Scart change-over switch

- Connection of 1-2 devices to a TV set via Scart connectors
- Manual selection of video sources (e.g. SAT, DVD, VCR)
- Two-way alternate rerecording capabilities (VCR1/VCR2)
- Switchable signal direction

EAN	Art.-Nr. item-no.	Länge length	DIY	VPE QTY
40009530	3246 8	-	-	4



Scart-Verteiler 3-fach

- Scart-Stecker – 3x Scart-Kupplungen
- Anschluss von 1-3 Geräten über Scart-Verbindungen an ein TV-Gerät
 - schlankes, platzsparendes Gehäusedesign
 - voll beschaltet, parallel

Scart distributor 3-way

- Scart plug – 3x Scart connectors
- Connection of 1-3 devices via Scart connections to a TV set
 - slim-line, space-saving casing design
 - fully wired, parallel

EAN	Art.-Nr. item-no.	Länge length	DIY	VPE QTY
40009530	23290 5	-	-	20



Video-Umschaltpult

Die Lösung für TV-/Video-Anschlussprobleme. Für alle Systeme in Mono und Stereo. Verbinden der verschiedenen Geräte durch einfachen Tastendruck. Kein Umstecken von Kabeln notwendig. Umschaltbare Aufnahme- und Wiedergabemöglichkeiten ohne lästiges Umstecken.

Beispiel: Videocassetten können kopiert werden und gleichzeitig können Programme vom SAT-Receiver gesehen werden.

- Drei Eingänge für z.B. Videorecorder, Camcorder und SAT-Receiver.
- Zwei Ausgänge für TV-Gerät und an weiteren Videorecorder oder Stereo-Anlage.

Video Switch-over Unit

The solution for TV/video connection problems. For all mono and stereo systems. Connect various devices at the push of a button. No plugging and unplugging of cables required. Switchable recording and playback possibilities without the annoying process of plugging and unplugging cables.

Example: Simultaneous copying of video cassettes and viewing of SAT receiver channels.

- Three inputs, e.g., for a video recorder, camcorder and SAT receiver.
- Two outputs for a TV set and a video recorder or stereo system

EAN	Art.-Nr. item-no.	Länge length	DIY	VPE QTY
40009530	2463 0	-	-	5

NETZWERK

NETWORK



Netzwerk RJ-45 Doppelkupplung

Zum Verbinden oder Verlängern zweier paralleler Netzwerkkabel (1:1 Patchkabel)

Network RJ-45 Double Connector

For connecting or extending two parallel network cables (1:1 patch cable)

EAN	Art.-Nr. item-no.	Länge length	DIY	VPE QTY
40009530	8508 2	-	-	8



Netzwerk Cross Over Kupplung

Kurzadapter zum Wandeln von parallelem Netzwerkkabel (1:1 Patchkabel) in Crossover-Kabel

Network Crossover Adapter

Short adapter for converting a parallel network cable (1:1 patch cable) into a crossover cable.

EAN	Art.-Nr. item-no.	Länge length	DIY	VPE QTY
40009530	8509 9	-	-	8

LAUTSPRECHER

Loudspeaker



Lautsprecher-Stecker

Lautsprecher-Stecker zur Selbstmontage, schraubbar

Loudspeaker plug

Loudspeaker plug for self-assembly, with screw thread

EAN	Art.-Nr. item-no.	Länge length	DIY	VPE QTY
40009530	3303 8	-	-	10



ISDN-Verteiler 1/2
 RJ45-Buchse – 2x RJ45-Buchse
 8-adrig verschalteter ISDN-Verteiler

ISDN distributor 1/2
 RJ45 jack – 2x RJ45 jack
 8-core fully-wired ISDN distributor

EAN	Art.-Nr. item-no.	Länge length	DIY	VPE QTY
40009530	7087 3	–	–	10



ISDN Doppelkupplung
 RJ45-Buchse – RJ45-Buchse
 Vollverschalteter ISDN-Leitungs-Verbinder

ISDN double connector
 RJ45 jack – RJ45 jack
 Fully-wired ISDN cable connector

EAN	Art.-Nr. item-no.	Länge length	DIY	VPE QTY
40009530	7086 6	–	–	10



RJ45 Stecker 8P8C
 ISDN-Stecker für Selbstmontage
 (Montage mit Crimpzange 7390 möglich)

RJ45 plug 8P8C
 ISDN plug for self-assembly (assembly possible using crimp tool 7390)

EAN	Art.-Nr. item-no.	Anzahl pieces	DIY	VPE QTY
40009530	7305 8	2	–	10



ISDN-Verteiler 1/2
 RJ45-Stecker – 2x RJ45-Buchse
 4-adrig verschalteter ISDN-Verteiler

ISDN distributor 1/2
 RJ45 plug – 2x RJ45 jack
 4-core fully-wired ISDN distributor

EAN	Art.-Nr. item-no.	Länge length	DIY	VPE QTY
40009530	7043 9	–	–	6r



Verteiler-Adapter TAE NFF
 Mit zusätzlicher RJ11-Buchse.
 4-adrig verschalteter Verteiler zum Anschluss von 2 Zusat-
 geräten und 2 Telefonen an einer F-Buchse.

Distributor adapter TAE NFF
 With additional RJ11 coupling.
 4-core fully-wired distributor for connecting 2 additional devices and
 two telephones to an F socket.

EAN	Art.-Nr. item-no.	Länge length	DIY	VPE QTY
40009530	7134 4	–	–	6



Modular-Doppelkupplung
 RJ11-Buchse – RJ11-Buchse

Modular double coupling
 RJ11 female jack – RJ11 female jack

EAN	Art.-Nr. item-no.	Länge length	DIY	VPE QTY
40009530	7145 0	–	–	10



RJ11-Stecker 6P4C

Modular-Stecker für Selbstmontage
(Montage mit Crimpzange 7390 möglich)

RJ11 plug 6P4C

Modular plug for self-assembly
(assembly possible using crimp tool 7390)

EAN	Art.-Nr. item-no.	Anzahl pieces	DIY	VPE QTY
40009530	7306	5	-	10



Zusatzgeräte-Anschlussadapter

RJ12-Buchse – TAE N-Stecker
Vollverschalteter Adapter für den Anschluss eines Zusatzgerätes

Accessory connector adapter

RJ12 socket – TAE N plug
Fully-wired adapter for connecting an additional device

EAN	Art.-Nr. item-no.	Länge length	DIY	VPE QTY
40009530	7110	8	-	10



Telefon-Anschlussadapter

RJ11-Buchse – TAE F-Stecker
4-adrig verschalteter Adapter für den Anschluss eines Telefons

Telephone connector adapter

RJ11 socket – TAE F plug
4-core fully-wired adapter for connecting one telephone

EAN	Art.-Nr. item-no.	Länge length	DIY	VPE QTY
40009530	7111	5	-	10



TAE F – DSL-Adapter 8P2C

TAE F-Stecker – Modulkupplung 8-polig (RJ45)

TAE F – DSL Adapter 8P2C

TAE F plug – Modular 8-pin connector (RJ45)

EAN	Art.-Nr. item-no.	Länge length	DIY	VPE QTY
40009530	7112	2	-	10

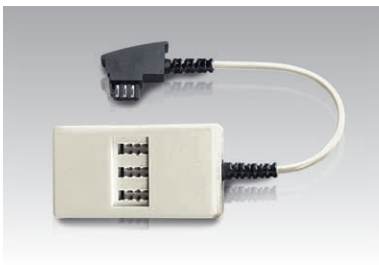

Verteiler-Adapter TAE NFN

Mit Anschlusskabel 0,2m
4-adrig verschalteter Verteiler zum Anschluss von 2 Zusatzgeräten und 1 Telefon an einer F-Buchse.

Distributor adapter TAE NFN

With connecting cable 0.2m
4-core fully-wired distributor for connecting 2 additional devices and 1 telephone to an F socket.

EAN	Art.-Nr. item-no.	Länge length	DIY	VPE QTY
40009530	7135	1	-	6

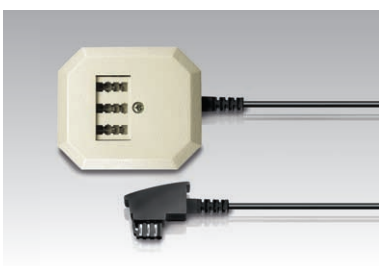

Verteiler-Adapter TAE NFF

Mit Anschlusskabel 0,2m + RJ11-Buchse.
4-adrig verschalteter Verteiler zum Anschluss von bis zu 2 Telefonen und 2 Zusatzgeräte an einer F-Buchse.

Distribution adapter TAE NFF

With connecting cable 0,2m + RJ11 socket.
4-wire connected distributor to connect up to 2 telephones and 2 accessories to an F-socket.

EAN	Art.-Nr. item-no.	Länge length	DIY	VPE QTY
40009530	7136	8	-	6



Telefon-Stecker
6-poliger TAE F-Stecker zur Selbstmontage

Telephone plug
6-pin TAE F plug for self-assembly

EAN	Art.-Nr. item-no.	Länge length	DIY	VPE QTY
40009530	7300 3	-	-	10



Telefon-Stecker
6-poliger TAE N-Stecker zur Selbstmontage

Telephone plug
6-pin TAE N plug for self-assembly

EAN	Art.-Nr. item-no.	Länge length	DIY	VPE QTY
40009530	7301 0	-	-	10

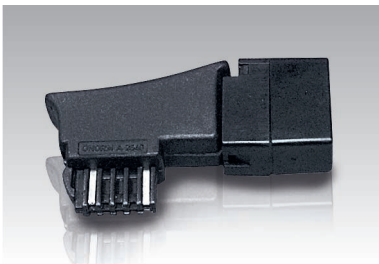

Anschlussadapter
TST-Stecker – RJ11-Buchse
4-adrig verschalteter Anschlussadapter für Telefone und Zusatzgeräte

Connector adapter
TST plug – RJ11 socket
4-core fully-wired connector adapter for telephones and accessories

EAN	Art.-Nr. item-no.	Länge length	DIY	VPE QTY
40009530	7451 2	-	-	10



Zubehör

Accessories

Verstärker / Verteiler	Amplifier / Distributor	58
Dosen SAT·Antenne·Telefon	Socket SAT·Antenna·Telephone	60
Montage	Mounting	63
Fernbedienungen	Remote control	66
Wandhalter	Brackets	68
Kopfhörer	Earphone	73
Akkus	Battery	74
Reinigung	Cleaning	74
Sonstiges	Others	74

Amplifier / Distributor	58
Socket SAT·Antenna·Telephone	60
Mounting	63
Remote control	66
Brackets	68
Earphone	73
Battery	74
Cleaning	74
Others	74



Breitband-Stammleitungsverteiler, 2-fach

Digitaltauglich für Antennen- und Satellitenfernsehen.
Gleichstrompfad, 5-2400 MHz, Dämpfung: <7 dB.

Broadband main distribution cable distributor, 2-way

Digital compatible for aerial and satellite televisions.
DC path, 5-2400 MHz, Attenuation: <7 dB.

EAN	Art.-Nr. item-no.	Länge length	DIY	VPE QTY
40009530	3732 6	-	-	4



Satellitensignal-Verstärker, 18 dB

Gleicht Signalverluste aus und optimiert die Bildqualität.
Empfohlen bei großen Kabellängen oder schlechter Bildqualität.

Satellite signal amplifier, 18 dB

Compensates for signal losses and optimises picture quality.
Recommended for long cable lengths or with poor picture quality.

EAN	Art.-Nr. item-no.	Länge length	DIY	VPE QTY
40009530	3747 0	-	-	4



TV-Zweigeräteverstärker

Für UKW/VHF/UHF
Frequenzbereich 47-860 MHz
Verstärkung 2x 10dB
Max. DVB-T-Eingangsspegel 74dBµV
Max. DVB-T-Ausgangsspegel 84dBµV
Betriebsspannung 230V/50Hz

TV Amplifier for 2 TV Sets

For FM/VHF/UHF
Frequency range 47-860 MHz
Amplification 2x 10dB
Max. DVB-T input level 74dBµV
Max. DVB-T output level 84dBµV
Operating voltage 230V/50Hz

EAN	Art.-Nr. item-no.	Länge length	DIY	VPE QTY
40009530	3562 9	-	-	10



Nachverstärker

Für UKW/VHF/UHF
Frequenzbereich 47-860 MHz
Verstärkung 20dB · Einstellbar 8-20dB
Max. DVB-T-Eingangsspegel 75dBµV
Max. DVB-T-Ausgangsspegel 95dBµV
Betriebsspannung 230V/50Hz

Adjustable Amplifier

For FM/VHF/UHF
Frequency range 47-860 MHz
Amplification 20dB · Settable between 8-20dB
Max. DVB-T input level 75dBµV
Max. DVB-T output level 95dBµV
Operating voltage 230V/50Hz

EAN	Art.-Nr. item-no.	Länge length	DIY	VPE QTY
40009530	3570 4	-	-	10



Verstärker für Kabelfernsehen

Zum Einsatz in BK-Anlagen nach dem Hausübergabepunkt. Zugelassen an Kabelverteilanlagen. Mit Sonderkanälen und Hyperband. Mit Pegelsteller, einfache Installation.
 Eingang: 47-862MHz • Pegelsteller: 0-20dB
 Netzanschluss: 230V/50Hz/3W • Verstärkung: 20dB
 Max. DVB-T Eingangspegel: 76dBµV
 Max. DVB-T Ausgangspegel: 96dBµV

Amplifier for cable television

For use with CATV systems after the house junction point. Approved for cable distribution systems. With special channels and hyperband. With level adjuster, simple installation.
 Input: 47-862MHz • Level adjuster: 0-20dB
 Mains connection: 230V/50Hz/3W • Amplification: 20dB
 Max. DVB-T input level: 76dBµV
 Max. DVB-T output level: 96dBµV

EAN	Art.-Nr. item-no.	Länge length	DIY	VPE QTY
40009530	3620 6	-	-	6

Amplifier
20 dB



Verstärker für Kabelfernsehen

Zum Einsatz in BK-Anlagen nach dem Hausübergabepunkt. Zugelassen an Kabelverteilanlagen. Mit Sonderkanälen und Hyperband. Mit Pegelsteller, einfache Installation.
 Eingang: 47-862MHz • Pegelsteller: 0-20dB
 Netzanschluss: 230V/50Hz/3W • Verstärkung: 30dB
 Max. DVB-T Eingangspegel: 88dBµV
 Max. DVB-T Ausgangspegel: 108dBµV

Amplifier for cable television

For use with CATV systems after the house junction point. Approved for cable distribution systems. With special channels and hyperband. With level adjuster, simple installation.
 Input: 47-862MHz • Level adjuster: 0-20dB
 Mains connection: 230V/50Hz/3W • Amplification: 30dB
 Max. DVB-T input level: 88dBµV
 Max. DVB-T output level: 108dBµV

EAN	Art.-Nr. item-no.	Länge length	DIY	VPE QTY
40009530	3622 0	-	-	6

Amplifier
30 dB

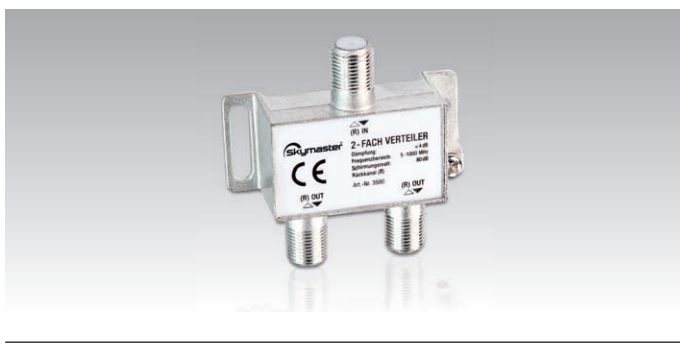

Stammleitungsverteiler, 2-fach

Empfohlen für Kabelfernsehen und Digital-TV (DVB). Rückkanaltauglich, Dämpfung <4 dB.

Main distribution cable distributor, 2-way

Recommended for cable television and digital TV (DVB). Feedback channel compatible, Attenuation <4 dB.

EAN	Art.-Nr. item-no.	Länge length	DIY	VPE QTY
40009530	3580 3	-	-	4



Stammleitungsverteiler, 3-fach

Empfohlen für Kabelfernsehen und Digital-TV (DVB). Rückkanaltauglich, Dämpfung <7 dB.

Main distribution cable distributor, 3-way

Recommended for cable television and digital TV (DVB). Feedback channel compatible, Attenuation <7 dB.

EAN	Art.-Nr. item-no.	Länge length	DIY	VPE QTY
40009530	13581 7	-	-	4



Sat-Antennendose, Single

Empfohlen für den Anschluss eines Satellitenreceivers. Auf- und Unterputzmontage möglich. Inklusive Antennenanschluss für terrestrischen Empfang (TV / Radio). Anschlussdämpfung < 3,5 dB.

Satellite aerial socket, single

Recommended for connecting one satellite receiver. Surface and flush mounting possible. Including aerial connector for terrestrial reception (TV / radio). Connector attenuation < 3.5 dB.

EAN	Art.-Nr. item-no.	Länge length	DIY	VPE QTY
40009530	3733 1	-	-	6



Sat-Antennendose, Twin

Empfohlen für den Anschluss zweier Satellitenreceiver. Auf- und Unterputzmontage möglich. Inklusive Antennenanschluss für terrestrischen Empfang (TV / Radio). Anschlussdämpfung < 3 dB.

Satellite aerial socket, twin

Recommended for connecting two satellite receivers. Surface and flush mounting possible. Including aerial connector for terrestrial reception (TV / radio). Connector attenuation < 3 dB.

EAN	Art.-Nr. item-no.	Länge length	DIY	VPE QTY
40009530	3733 1	-	-	6

ANTENNE

ANTENNA



Antennen-Durchgangsdose, universal

Durchgangsdose für Kabel- und Antennenfernsehen. Mit Abschlusswiderstand (75 Ω) auch als Enddose verwendbar. Auf- und Unterputzmontage möglich. Anschlussdämpfung: <14dB. • Durchgangsdämpfung: <1,2dB.

Aerial through socket, universal

Through socket for cable and aerial television. With termination resistor (75 Ω), can also be used as an end socket. Surface and flush mounting possible. Connector attenuation: <14dB. • Throughput attenuation: <1.2 dB.

EAN	Art.-Nr. item-no.	Länge length	DIY	VPE QTY
40009530	3533 9	-	-	6



Antennen-Enddose, universal

Enddose für Kabel- und Antennenfernsehen. Auf- und Unterputzmontage möglich. Anschlussdämpfung: < 2 dB.

Aerial end socket, universal

End socket for cable and aerial television. Surface and flush mounting possible. Connector attenuation: < 2 dB.

EAN	Art.-Nr. item-no.	Länge length	DIY	VPE QTY
40009530	3522 3	-	-	6



Antennendose, rückkanaltauglich

Empfohlen für Kabelfernsehen und digital TV (DVB-T) als End- und Durchgangsdose. Auf- und Unterputzmontage. Mit Abschlusswiderstand (75 Ω) auch als Enddose verwendbar. Anschlussdämpfung: <10 dB • Durchgangsdämpfung: <4,5 dB.

Aerial through socket, feedback channel compatible

Recommended for cable television and digital TV (DVB-T) as an end socket and as a through socket. Surface and flush mounting. With termination resistor (75 Ω), can also be used as an end socket. Connector attenuation: <10 dB • Throughput attenuation: <4.5 dB.

EAN	Art.-Nr. item-no.	Länge length	DIY	VPE QTY
4000953	35333 4	-	-	6



Antennen-Enddose, rückkanaltauglich

Empfohlen für Kabelfernsehen und digital TV (DVB-T) als Enddose. Abschlusswiderstand vormontiert. Auf- und Unterputzmontage. Bei Entfernung des 75 Ω Abschlusswiderstandes als Durchgangsdose verwendbar. Anschlussdämpfung: <11 dB

Aerial end socket, feedback channel compatible

Recommended as an end socket for cable television and digital TV (DVB-T). Termination resistor pre-fitted. Surface and flush mounting. Can be used as a through socket by removing the 75 Ω termination resistor. Connector attenuation: <11 dB

EAN	Art.-Nr. item-no.	Länge length	DIY	VPE QTY
4000953	35332 7	-	-	6



CAT5-Anschlussdose 2x8 (8)

2x RJ45-Buchse geschirmt – Aufputzmontage.
Vollverschaltete geschirmte Anschlussdose für den parallelen Anschluss von ISDN, DSL oder Netzwerkkabel.

CAT5 socket 2x8 (8)

2x RJ45 socket, screened – surface mounting.
Fully-wired, screened socket for the parallel connection of ISDN, DSL or network cables.

EAN	Art.-Nr. item-no.	Länge length	DIY	VPE QTY
40009530	7228 0	-	-	4



CAT5-Anschlussdose 2x8 (8)

2x RJ45-Buchse geschirmt – Unterputzmontage.
Vollverschaltete geschirmte Anschlussdose für den parallelen Anschluss von ISDN, DSL oder Netzwerkkabel

CAT5 socket 2x8 (8)

2x RJ45 socket, screened – flush mounting.
Fully-wired, screened socket for the parallel connection of ISDN, DSL or network cables.

EAN	Art.-Nr. item-no.	Länge length	DIY	VPE QTY
40009530	7229 7	-	-	4



Anschlussdose TAE NFN

Aufputzinstallation
Anschlussdose für 2 Zusatzgeräte und 1 Telefon

TAE NFN socket

Surface-mounted
Socket for 2 additional devices and 1 telephone

EAN	Art.-Nr. item-no.	Länge length	DIY	VPE QTY
40009530	7208 2	-	-	6
4000953	27208 6	-	•	14



Anschlussdose TAE NFN

Unterputzinstallation
Anschlussdose für 2 Zusatzgeräte und 1 Telefon

TAE NFN socket

Flush-mounted
Socket for 2 additional devices and 1 telephone

EAN	Art.-Nr. item-no.	Länge length	DIY	VPE QTY
40009530	7209 9	-	-	6
4000953	27209 3	-	r	14



Anschlussdose TAE NF/F

Aufputzinstallation.
Anschlussdose für 1 Zusatzgerät und 2 Telefone an 2 Hauptanschlüssen.

TAE NF/F socket

Surface-mounted
Socket for 1 additional device and 2 telephones on 2 main lines.

EAN	Art.-Nr. item-no.	Länge length	DIY	VPE QTY
40009530	7210 5	-	-	6



Anschlussdose TAE NF/F

Unterputzinstallation.
Anschlussdose für 1 Zusatzgerät und 2 Telefone an 2 Hauptanschlüssen.

TAE NF/F socket

Flush-mounted.
Socket for 1 additional device and 2 telephones on 2 main lines.

EAN	Art.-Nr. item-no.	Länge length	DIY	VPE QTY
40009530	7211 2	-	-	6



Universal TAE Anschlussdose

Aufputzinstallation.

Anschlussdose für ein Zusatzgerät z.B. Modem oder ein Telefon.

Universal TAE socket

Surface-mounted installation.

Socket for one additional device, e.g. modem or telephone.

EAN	Art.-Nr. item-no.	Länge length	DIY	VPE QTY
40009530	7218 1	-	-	6



Universal TAE Anschlussdose

Unterputzinstallation.

Anschlussdose für ein Zusatzgerät z.B. Modem oder ein Telefon.

Universal TAE socket

Flush installation.

Socket for one additional device, e.g. modem or telephone.

EAN	Art.-Nr. item-no.	Länge length	DIY	VPE QTY
40009530	7219 8	-	-	6r



Anschlussdose TAE F/F

Unterputzinstallation.

Anschlussdose für 2 Telefone an 2 Hauptanschlüssen.

TAE F/F socket

Flush-mounted.

Socket for 2 telephones on 2 main lines.

EAN	Art.-Nr. item-no.	Länge length	DIY	VPE QTY
40009530	7205 1	-	-	6r



Anschlussdose TAE U/U

Unterputzinstallation.

Universal-Anschlussdose für Telefone oder Zusatzgeräte an 2 Hauptanschlüssen.

TAE U/U connection socket

Flush installation.

Universal connection socket for telephones and auxiliaries to 2 main lines.

EAN	Art.-Nr. item-no.	Länge length	DIY	VPE QTY
40009530	7199 3	-	-	6



Mauerhalterung

Aluminium-Rohrdurchmesser: 50mm
 Extrem sichere Befestigung durch 4-Loch Montageplatte.
 „Anti-Whisper“-Kappe mit Regenschutz.
 Für alle Antennengrößen bis 1,20m Durchmesser.
 TÜV geprüfte Qualitätskonstruktion.

Wall fixing

Aluminium tube diameter: 50mm
 Extremely reliable fixing due to 4-hole mounting plate. Rainproof "anti-whisper" cap.
 For all aerial sizes up to 1.20m diameter. Proofed quality by TÜV.

EAN	Art.-Nr. item-no.	Länge length	DIY	VPE QTY
40009530	3862 0	25cm	•	1
40009530	3863 7	35cm	•	1
40009530	3864 4	45cm	•	1



Universal Balkonhalter

Ermöglicht die Montage von Außenantennen aller Art an Balkonen, Geländern und Masten.
 • TÜV/GS geprüfter hochwertiger Aluminiumhalter
 • Oberflächenveredelte Anbauteile mit Korrosionsschutz ermöglicht hohe Lebensdauer
 • Rohrdurchmesser: 50mm

Universal balcony mounting bracket

Enables you to mount all outdoor antennas to balconies, railings and masts.
 • TÜV/GS tested, high-quality aluminium bracket
 • Surface treated add-on pieces with corrosion protection ensure a long service life
 • Tube diameter: 50mm

EAN	Art.-Nr. item-no.	Länge length	DIY	VPE QTY
40009530	3746 3	25cm	•	1



Universal Balkonständer rostfrei

Ermöglicht die Montage von Außenantennen aller Art auf Balkonen, Terrassen oder im Garten.
 • Einstellbare GummifüÙe zur waagerechten Ausrichtung des Standfußes.
 • Optimierter Standfuß zur Aufnahme einer Gehwegplatte* (50 x 50 cm) zur Erhöhung der Standsicherheit.
 • Masthöhe: 1m • Mastdurchmesser: 40mm
 • Maximale Sat-Antennengröße: < 90cm

Universal balcony stand

Enable the mounting of all types of external antenna on balconies, patios or in garden.
 • Adjustable rubber feet for horizontal alignment of the stand.
 • Optimised stand for insertion of a paving slab*(50x50cm) for increased stability.
 • Mast height: 1m • Mast diameter: 40mm
 • Maximum sat antenna size: < 90cm

EAN	Art.-Nr. item-no.	Länge length	DIY	VPE QTY
40009530	3865 1	1,0m	-	4

*nicht im Lieferumfang enthalten!
 not included!



Mauerhalterung für Antennenmasten

Sehr stabile Ausführung für die Wandmontage von Satellitenanlagen. Bestehend aus zwei Haltebügeln, davon besitzt einer eine Zusatzstütze. Für Antennenmasten bis 60mm Durchmesser. Maximaler Halterabstand: 30cm.

Wall fixture for aerial mast

Extremely robust design for wall mounting of satellite systems. Consisting of two fixing clamps, one of which additional support. For aerial masts up to 60mm diameter. Maximum bracket distance: 30cm.

EAN	Art.-Nr. item-no.	Länge length	DIY	VPE QTY
40009530	3764 7	-	-	1

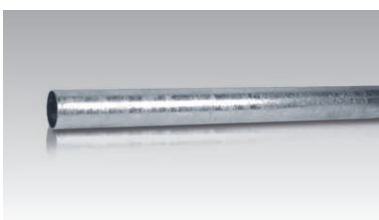

Antennenmast

Stahlmast, feuerverzinkt

Aerial mast

Steel, hot galvanized

EAN	Art.-Nr. item-no.	Länge length	DIY	VPE QTY
40009530	3760 9	1,0m	-	1
40009530	3761 6	2,0m	-	1



Universal Mastmountage Set

Zur sichere Befestigung von Antennen- und Satellitenmasten mit Ø 48 bis 55 mm. Ideale Ergänzung zur Universaldachpfanne von Skymaster®. Hochwertige, korrosionsgeschützte Metallbefestigungen mit Erdungsanschluss. Schützt vor eindringender Feuchtigkeit und Wasserschäden.

Set beinhaltet:

- 1x Mastschelle mit 4 x 9mm Befestigungslöchern
- 1x Mastfuß mit 4 x 9mm Befestigungslöchern
- 1x Mastkappe
- 1x Dichtungsmanschette
- 1x Isolierband
- 10x Nagelschellen 4 bis 7mm

Universal mast fitting kit

For the secure fixing of aerial and satellite masts with Ø48 to 55 mm. Ideally complements the Skymaster®universal roof tile. High-quality, corrosion protected metal fixings with earth connector. Protects against penetrating damp and water damage.

Kit includes:

- 1x Mast clamp with 4 x 9 mm fixing holes,
- 1x Mast foot with 4 x 9 mm fixing holes
- 1x Mast cap, 1x Sealing sleeve, 1x Insulating strip,
- 10x cable clips 4 to 7 mm

EAN	Art.-Nr. item-no.	Länge length	DIY	VPE QTY
4000953	35405 8	-	-	20



Mastbefestigungsschelle

Zur Befestigung von Antennenmasten

Mast fixing clamp

For securing aerial masts

EAN	Art.-Nr. item-no.	Ø	DIY	VPE QTY
4000953	35402 7	48mm	-	4
4000953	35412 6	42mm	-	6



Mastkappe

Wetterschutzkappe für Masten von 42-60 mm.

Mast cap

Weather-proof cap for masts from 42-60 mm.

EAN	Art.-Nr. item-no.	Länge length	DIY	VPE QTY
4000953	35403 4	-	-	4

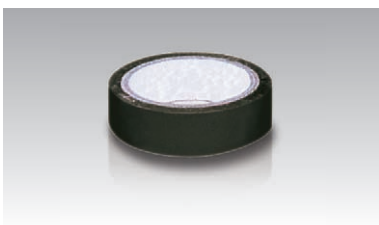

Dicht- und Montageband

Schützt von eindringender Feuchtigkeit in Kabelverbindungen. Zur Montage, Isolation und Fixierung von Kabeln aller Art.

Sealing and installation tape

Protects against water penetration in cable connections. For the installation, insulation and attachment of every type of cable.

EAN	Art.-Nr. item-no.	Länge length	DIY	VPE QTY
4000953	35404 1	-	-	9



Universelle Mastabdichtung zwischen Dachpfanne und Mastdurchführung

Passende Skymaster Dachabdeckung Artikel: 35410.

Langlebige und UV-beständige Gummimischung. Passend für Masten zwischen 35-50 mm Durchmesser.

Universal Mast Seal between Pantile and Mast Bushing

Suitable Skymaster roof covering article:35410.

Durable and UV-resistant rubber compound. Suitable for 35-50 mm diameter masts.

EAN	Art.-Nr. item-no.	Länge length	DIY	VPE QTY
4000953	35406 5	-	-	6

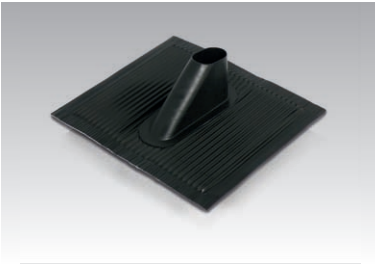

Universal Dachabdeckung

Plastik mit Aluminium, schwarz

Für die Dachinstallation von Satellit- und Antennenmasten. Passt auf nahezu alle Dächer z.B. S-Pfanne oder Blechdach.

Universal roof covering

Plastic with aluminium, black

For roof installation of satellite aerial masts. Suitable for most roofs, e.g. S-pantile or sheet metal roof.

EAN	Art.-Nr. item-no.	Länge length	DIY	VPE QTY
4000953	35410	2	-	1



Schrauben-Set für Mauerhalterungen

Korrosionsgeschützte Schlüsselschrauben inklusive Dübel und Unterlegscheiben. Zur sicheren Befestigung von Antennen und Mauerhalterungen.

4x Schlüsselschrauben, 7x80mm, 4x Unterlegscheiben, 4x Dübel, 12mm.

Screw set for wall fixing

Corrosion protection hexagonal-head screws including wall plugs and washers. For secure fixing of aerials and wall brackets.

4x hexagonal-head screws, 7x80mm, 4x washers, 4x wall plugs, 12mm.

EAN	Art.-Nr. item-no.	Länge length	DIY	VPE QTY
40009530	3597	1	-	10



Abisoliermesser für Koaxial-Kabel

Kompakte Grifffläche mit Abstandsmarkierung zur Abisolierung von Innen- und Außenleiter. Verhindert Unterbrechungen des Schirmgeflechtes und beugt Verletzungen vor.

Stripping knife for coaxial cable

Compact gripping surface with distance markers for stripping inner and outer conductor. Avoids interrupting the screening braid and prevents injuries.

EAN	Art.-Nr. item-no.	Länge length	DIY	VPE QTY
40009530	3561	2	-	4r



Nagelschellen

Zur Befestigung von Kabeln mit einem Durchmesser von 4-7mm. Rostfreie Stahlnägel vormontiert, Schellenfarbe weiss.

Cable clips

For fixing cables with a diameter of 4-7mm. Rust-free steel nails pre-fitted, clip colour white.

EAN	Art.-Nr. item-no.	Anzahl Pieces	DIY	VPE QTY	
40009530	3543	8	25	-	10



Universal Crimpzange

Crimpzange zur Selbstmontage von Modular- oder Western-Stecker der Größen RJ10, RJ11, RJ12, RJ45

Universal crimp tool

Crimp tool for self-assembly of modular or Westernplugs, size RJ10, RJ11, RJ12, RJ45

EAN	Art.-Nr. item-no.	Länge length	DIY	VPE QTY	
40009530	7390	4	-	•	20



Universal 10 in 1 Fernbedienung, lernfähig

Ersetzt bis zu 10 Fernbedienungen!

- Steuert die am meisten benutzten Standardfunktionen (Video-text-, Menü- oder Playerfunktion)
- Geeignet für 2x TV/VCR/CBL/SAT/AMP/CD/Tape/Tuner/DVD/Aux
- Gerätetasten frei mit Geräten belegbar
- Lernfähig zum Kopieren jeder Funktion Ihrer Originalfernbedienung
- Einfache Programmierung • Umfangreiche Code Bibliothek
- Direkte Code Eingabe • Code Suchlauf

Universal 10 in 1 Remote Control, adaptive

Replaces up to 10 remote controls!

- Controls the most used standard functions (teletext, menu or player function)
- Suitable for 2x TV / VCR / CBL / SAT / AMP / CD / tape / tuner / DVD / Aux
- Devices can be freely allocated to device buttons
- Can copy each function of your original remote control
- Simple programming • Extensive code library
- Direct code input • Code search run

EAN	Art.-Nr. item-no.	Länge length	DIY	VPE QTY
40009530	2433 3	-	-	10



Universal 8 in 1 Fernbedienung

Ersetzt bis zu 8 Fernbedienungen!

- Steuert die am meisten benutzten Standardfunktionen (Videotext-, Menü- oder Playerfunktion)
- Geeignet für TV / VCR / CBL/SAT / AMP / CD / Tape / Tuner / DVD
- Gerätetasten frei mit Geräten belegbar
- Leuchtende Gerätetastenanzeige • Einfache Programmierung
- Umfangreiche Code Bibliothek • Direkte Code Eingabe
- Code Suchlauf!

Universal 8 in 1 Remote Control

Replaces up to 8 remote controls!

- Controls the most used standard functions (teletext, menu or player function)
- Suitable for TV / VCR / CBL/SAT / AMP / CD / Tape / Tuner / DVD
- Devices can be freely allocated to device buttons
- Illuminated device button display • Simple programming
- Extensive code library • Direct code input • Code search run

EAN	Art.-Nr. item-no.	Länge length	DIY	VPE QTY
40009530	2432 6	-	-	10



Universal 4 in 1 Fernbedienung

Ersetzt bis zu 4 Fernbedienungen!

- Steuert die am meisten benutzten Standardfunktionen (Videotext-, Menü- oder Playerfunktion)
- Geeignet für TV / VCR / CBL/SAT / DVD
- Gerätetasten frei mit Geräten belegbar
- Leuchtende Gerätetastenanzeige • Einfache Programmierung
- Umfangreiche Code Bibliothek • Direkte Code Eingabe
- Code Suchlauf!

Universal 4 in 1 Remote Control

Replaces up to 4 remote controls!

- Controls the most used standard functions (teletext, menu or player function)
- Suitable for TV / VCR / CBL /SAT / DVD
- Devices can be freely allocated to device buttons
- Illuminated device button display • Simple programming
- Extensive code library • Direct code input • Code search run

EAN	Art.-Nr. item-no.	Länge length	DIY	VPE QTY
40009530	2431 9	-	-	10



Universal 2 in 1 „Zapper“ Fernbedienung

Ersetzt bis zu 2 Fernbedienungen!

- Steuert die wichtigsten Standardfunktionen (Kanal +/-, Lautstärke +/-, Stummschaltung, AN/AUS)
- Geeignet für TV / SAT • Leuchtende Gerätetastenanzeige
- Einfache Programmierung • Umfangreiche Code Bibliothek
- Code Suchlauf

Universal 2 in 1 “Zapper” Remote Control

Replaces up to 2 remote controls!

- Controls the most important standard functions (channel +/-, volume +/-, mute, ON/OFF)
- Suitable for TV / SATELLITE • Illuminated device button display
- Simple programming • Extensive code library • Code search run

EAN	Art.-Nr. item-no.	Länge length	DIY	VPE QTY
40009530	2430 2	-	-	10



Universal 8in1 Fernbedienung

Ersetzt bis zu 8 Fernbedienungen!

- Steuert die am meisten benutzten Standardfunktionen (Videotext-, Menü- oder Playerfunktion)
- Geeignet für TV-Geräte / SAT-Receiver / DVD-Player / etc.
- Einfache Programmierung • Umfangreiche Code Bibliothek
- Direkte Code Eingabe • Code Suchlauf!

Universal 8 in 1 Remote Control

Replaces up to 8 remote controls!

- Controls the most used standard functions (teletext, menu or player function)
- Suitable for TV Set / SAT receiver / DVD player / etc
- Simple programming • Extensive code library
- Direct code input • Code search run

EAN	Art.-Nr. item-no.	Länge length	DIY	VPE QTY
40009530	2422 7	-	-	10



Universal 4 in 1 Fernbedienung

Ersetzt bis zu 4 Fernbedienungen!

- Steuert die am meisten benutzten Funktionen (Videotext-, Menü- oder Playerfunktion) • Geeignet für TV/ DVD/VCR / AUDIO/ SAT
- Direktzugriff auf Gerätemodus, Menü, Programme, Lautstärke
- Tastenfeld kann eingedreht werden • Mit LCD-Timer (Uhrzeit)

Universal 4 in 1 Remote Control

Replaces up to 4 remote controls!

- Controls the most used functions (teletext, menu or player function)
- Suitable for TV/ DVD/VCR / AUDIO/ SAT • Direct access to device mode, menu, channels, volume • Keypad flap can be swivelled • With LCD timer (time)

EAN	Art.-Nr. item-no.	Länge length	DIY	VPE QTY
40009530	2435 7	-	-	6



Universal 4 in 1 Fernbedienung

Ersetzt bis zu 4 Fernbedienungen!

- Steuert die am meisten benutzten Funktionen (Videotext-, Menü- oder Playerfunktion) • Geeignet für TV/ DVD/VCR / AUDIO/ SAT
- Direktzugriff auf Gerätemodus, Menü, Programme, Lautstärke
- Mit Schiebevorrichtung

Universal 4 in 1 Remote Control

Replaces up to 4 remote controls!

- Controls the most used functions (teletext, menu or player function)
- Suitable for TV/ DVD/VCR / AUDIO/ SAT • Direct access to device mode, menu, channels, volume • with sliding mechanism

EAN	Art.-Nr. item-no.	Länge length	DIY	VPE QTY
40009530	2436 4	-	-	6

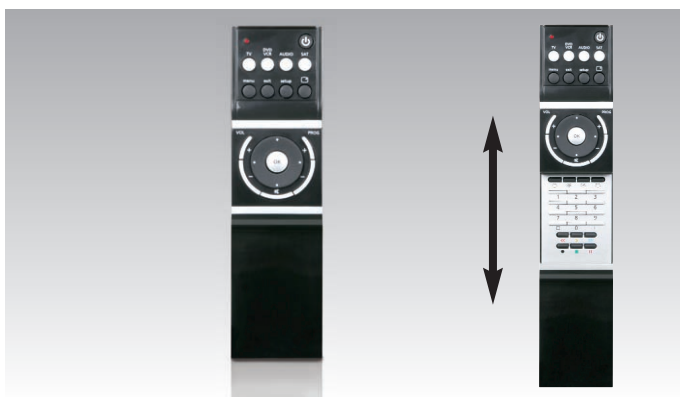

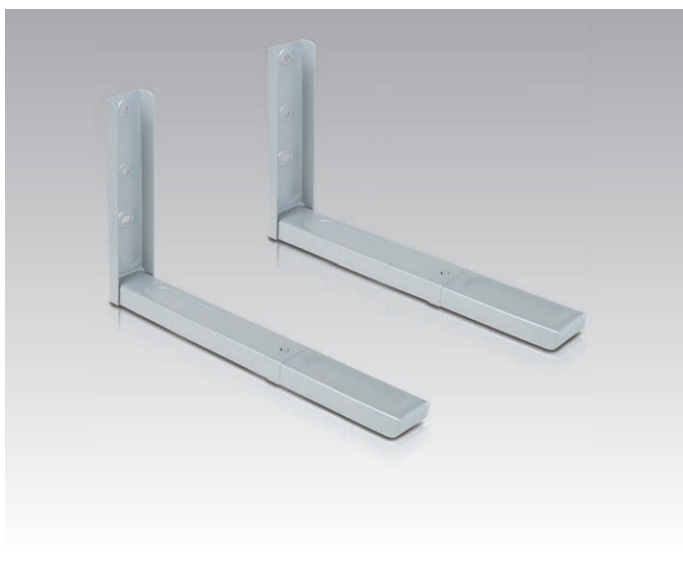

Mikrowellen-Halter HMW 40/MW-40S

- Passend für alle herkömmlichen Mikrowellen oder auch andere Haushaltsgeräte
- Längenverstellbar von 330 bis 430mm
- Maximale Belastbarkeit 40 kg
- TÜV/GS geprüft
- Wandmontageschrauben nicht im Lieferumfang enthalten

Microwave bracket HMW 40/MW-40S

- Suitable for loudspeakers, microwaves and other heavy domestic appliances
- Length adjustable from 330 to 430 mm
- Maximum loading 40 kg
- TÜV/GS tested
- Wall-mounting screws are not included in the scope of delivery

EAN	Art.-Nr. item-no.	Farbe colour	DIY	VPE QTY
40009530	2742 6	weis	-	4
40009530	2722 8	silber	-	4



Universal LCD-Halter LCD-G030U

- für Bildschirmdiagonalen bis 32" (81 cm)
- Maximale Belastbarkeit 30 kg
- Universell passend nach VESA-Standards: 50, 75, 100, 200 oder 100x200mm
- Wandabstand nur ca. 17 mm

Universal LCD Bracket LCD-G030U

- For up to 32" (81 cm) screens (diagonal measurement)
- Maximum load capacity 30 kg
- Universal compatibility according to VESA standards: 50, 75, 100, 200 or 100x200 mm
- Distance from wall only approx. 17 mm

EAN	Art.-Nr. item-no.	Länge length	DIY	VPE QTY
40009530	2720 4	-	-	14



LCD-Wandhalterung

für Bildschirmdiagonalen 10"-21" (25-53 cm)

- Maximale Belastbarkeit 15 kg
 - Neigungswinkel: -10°, stufenlos einstellbar
 - Universell passend durch Langlochbefestigung
 - Lochabstand von 30x30 – 130x130 mm, auch nach VESA-Standard
- Abmessungen:
- Monitorbefestigungsplatte: 150x150 mm
 - Wandbefestigungsplatte: 145x70 mm
 - Wandabstand ca. 40mm

LCD Wall Bracket

For screen diagonals 10"-21" (25-53 cm)

- Maximum capacity 15kg
- Tilt angle -10°, infinitely adjustable
- Fits universally though oblong hole attachments
- Hole distance of 30x30 – 130x130 mm also in accordance with the VESA-Standard

Dimensions:

- Monitor mounting bracket: 150x150mm
- Wall mounting bracket: 145x70mm
- Wall distance about 40mm

EAN	Art.-Nr. item-no.	Länge length	DIY	VPE QTY
4000953	27301 4	-	-	6





LCD-/Monitor-Halter LCD-D100

- Hochwertiger, stabiler Wandhalter aus Aluminium
- Geeignet für Flachbildschirme 33-76 cm (13"-30")
- Maximale Belastbarkeit: 18 kg
- Entspricht den Vorgaben nach VESA 75, 100
- Flache Wandkonstruktion
- Betrachtungsposition optimal einstellbar (neig- und schwenkbar)
- Einfache Montage
- Einstellschraube zur Fixierung der gewünschten Position
- Rasthaken für zusätzliche Sicherung
- Integrierte Kabelführung
- Gesamtabmessung: 580 x 350 x 82 mm

LCD Monitor bracket LCD-D100

- High quality, rigid aluminium ball bracket
- Suitable for flat-screen monitors 33-76 cm (13"-30")
- Maximum load: 18 kg
- Complies with VESA 75, 100
- Flat wall-mounted design
- Optimally adjustable viewing position (can be tilted and swivelled)
- Simple mounting
- Adjusting screw to fix the required position
- Locking hook for additional safety
- Integrated cable guide
- Overall dimensions: 580 x 350 x 82 mm

EAN	Art.-Nr. item-no.	Länge length	DIY	VPE QTY
40009530	2744 0	-	-	6



LCD-/Monitor-Halter LCD-DA100

- Hochwertiger, stabiler Wandhalter aus Aluminium
- Geeignet für Flachbildschirme 33-76 cm (13"-30")
- Maximale Belastbarkeit: 18 kg
- Entspricht den Vorgaben nach VESA 75, 100
- Betrachtungsposition optimal einstellbar (neig- und schwenkbar)
- Einstellschraube zur Fixierung der gewünschten Position
- Rasthaken für zusätzliche Sicherung
- Integrierte Kabelführung
- Gesamtabmessung: 580 x 350 x 82 mm

LCD Monitor bracket LCD-DA100

- High quality, rigid aluminium ball bracket
- Suitable for flat-screen monitors 33-76 cm (13"-30")
- Maximum load: 18 kg
- Complies with VESA 75, 100
- Optimally adjustable viewing position (can be tilted and swivelled)
- Adjusting screw to fix the required position
- Locking hook for additional safety
- Integrated cable guide
- Overall dimensions: 580 x 350 x 82 mm

EAN	Art.-Nr. item-no.	Länge length	DIY	VPE QTY
40009530	2745 7	-	-	6





LCD Wandhalterung PLLCD-G056

- Für Bildschirmdiagonalen: 66 - 94 cm
- Maximale Belastbarkeit: 56 kg
- Universelle Halterung – entspricht den Vorgaben nach VESA 75 x 75, 100 x 100, 200 x 100, 200 x 200 mm und ist darüber hinaus variabel einstellbar
- 2 Bewegliche Tragarme, stufenlos breitenverstellbar (horizontal), variabler Abstand der Aufnahmebohrungen (vertikal)
- Max. Lochabstand Tragsarme: Breite 370 mm · Höhe 320 mm
- Wandabstand: 6 cm
- Einfaches Ausrichten dank vorhandener Wasserwaage
- Inklusive Sicherheitsbügel und Kabelhalterung
- Gesamtabmessung: 540 x 350 x 60 mm

LCD Wall Mount Bracket PLLCD-G056

- For diagonal screen size: 66 - 94 cm · Maximum load: 56 kg
- Universal bracket supports VESA standards 75 x 75, 100 x 100, 200 x 100, 200 x 200 mm and can be variably adjusted
- 2 adjustable mounting arms, stepless width adjustment (horizontally), variable distance of the mounting holes (vertically)
- Max. hole distance width: 370 mm · height: 320 mm
- Distance from wall: 6 mm
- Quick and simple alignment due to integrated spirit level
- Includes safety bar and cable holder
- Dimensions: 540 x 350 x 60 mm

EAN	Art.-Nr. item-no.	Länge length	DIY	VPE QTY
40009530	2732 7	-	-	3

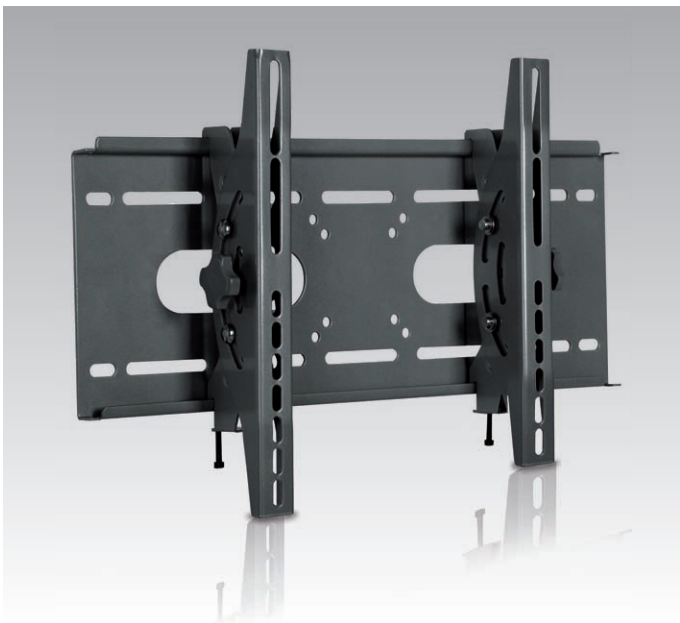

Universal LCD-/Plasma-Halter LCD/PL-N400, neigbar

- Hochwertige Metallausführung in matt-schwarz
- Geeignet für Flachbildschirme 58-94 cm (23"-37")
- Maximale Belastbarkeit: 56 kg
- Vormontierte, kippbare Halteschienen
- Universell einsetzbar – nach VESA 75, 100, 200x100, 200, 400x200 mm und darüber hinaus variabel einstellbar
- Max. Lochabstände der Halteschienen: Breite: 500 mm, Höhe: 322 mm
- Einfache Montage!
- Inkl. Sicherungsfunktion

Universal tilting LCD/plasma bracket LCD/PL-N400

- High quality matt black metal design
- Suitable for flat-screen monitors 58-94 cm (23"-37")
- Maximum load: 56 kg
- Pre-mounted, tilting holding bars
- Universal use – complies with VESA 75, 100, 200x100, 200, 400x200 mm and can also be variably adjusted
- Max. distance between holding bar holes: Width: 500 mm, height: 322 mm
- Simple mounting
- Includes securing function

EAN	Art.-Nr. item-no.	Länge length	DIY	VPE QTY
40009530	2748 8	-	-	3



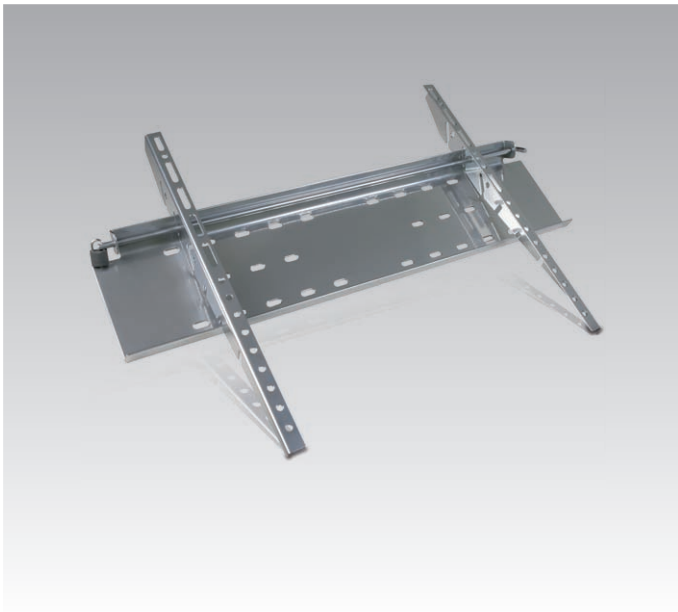

Universal LCD/Plasma Wandhalterung LCD/PL-F600

- Für Bildschirmdiagonalen: 81 - 165 cm (32" - 65")
- Maximale Belastbarkeit: 79 kg
- Universelle Halterung – entspricht den Vorgaben nach VESA 75, 100, 200 x 100, 200, 400, 600 x 200, 600 x 400 mm und ist darüber hinaus variabel einstellbar
- Stufenlos breitenverstellbar
- Variable Lochabstände der Befestigungsschienen
- Max. Lochabstand Breite: 660 mm • Höhe: 440 mm
- Wandabstand: 5,5 cm
- Inklusive Sicherungsstab und Diebstahlsicherung
- Gesamtabmessung: 715 x 172 x 30 mm

Universal LCD/Plasma Wall Mount LCD/PL-F600

- For diagonal screen size: 81 - 165 cm (32" - 65")
- Maximum load: 79 kg
- Universal bracket supports VESA standards 75, 100, 200 x 100, 200, 400, 600 x 200, 600 x 400 mm and can be variably adjusted
- Stepless width adjustment
- Variable distance of the mounting holes
- Max. hole distance width: 660 mm • height: 440 mm
- Distance from wall: 5,5 cm
- Includes safety device and padlock
- Dimensions: 715 x 172 x 30 mm

EAN	Art.-Nr. item-no.	Länge length	DIY	VPE QTY
40009530	2736 5	-	-	3

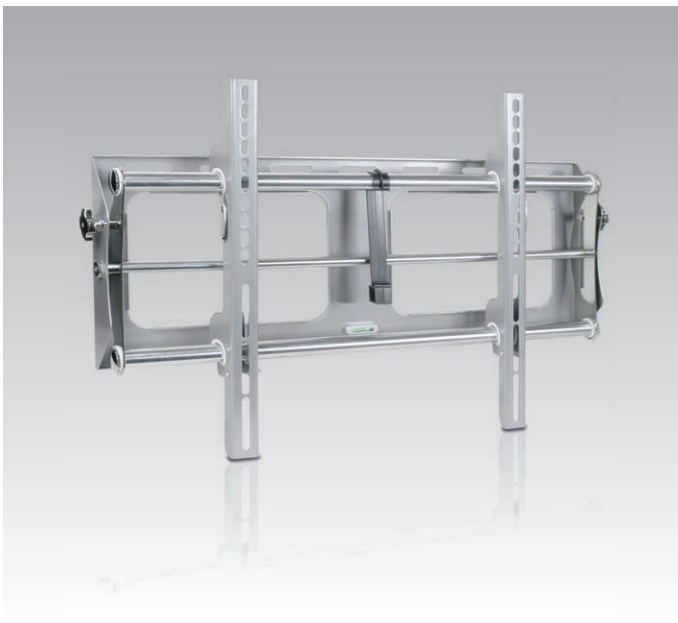

Plasma/LCD-Wandhalterung PLLCD-G189, neigbar

- Für Bildschirmdiagonalen: 94 - 152cm
- Maximale Belastbarkeit: 89 kg
- Neigung stufenlos einstellbar: +/-15°
- Universelle Halterung – entspricht den Vorgaben nach VESA 100 x 100, 200 x 100, 200 x 200, 400 x 400, 600 x 200, 600 x 400mm und ist darüber hinaus variabel einstellbar
- 2 bewegliche Tragarme, stufenlos breitenverstellbar (horizontal), variabler Abstand der Aufnahmebohrungen (vertikal)
- Max. Lochabstand Breite: 680mm • Höhe: 490mm
- Wandabstand: max. 9cm
- Einfaches Ausrichten dank vorhandener Wasserwaage
- Inklusive Sicherheitsbügel und Kabelhalterung
- Gesamtabmessung: 810 x 530 x 90mm

Tiltable Plasma/LCD Wall Mount Bracket PLLCD-G189

- For diagonal screen size: 94 - 152 cm
- Maximum load: 89 kg
- Stepless tilt adjustment: +/-15°
- Universal bracket supports VESA standards 100 x 100, 200 x 100, 200 x 200, 400 x 400, 600 x 200, 600 x 400mm and can be variably adjusted
- 2 adjustable mounting arms, stepless width adjustment (horizontally), variable distance of the mounting holes (vertically)
- Max. hole distance width: 680mm • height: 490mm
- Distance from wall: max. 9cm
- Quick and simple alignment due to integrated spirit level
- Includes safety bar and cable holder
- Dimensions: 810 x 530 x 90mm

EAN	Art.-Nr. item-no.	Länge length	DIY	VPE QTY
40009530	2735 8	-	-	3



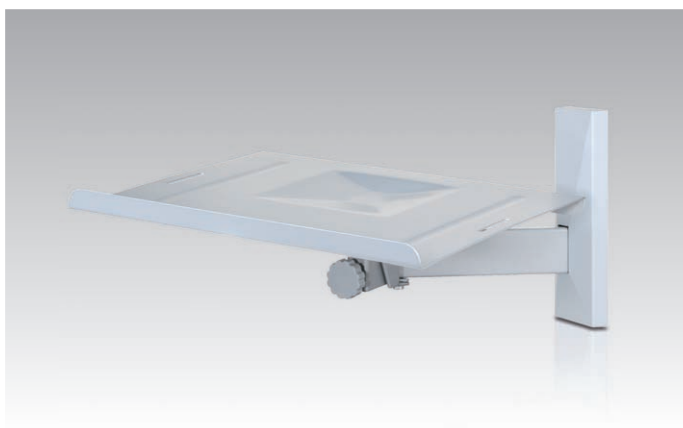

TV-Halter HTV 14

- Für Bildschirmgrößen bis 43cm
- Maximale Belastbarkeit 30 kg
- Auflagefläche 317 x 280mm
- Schwenkbar: horizontal 220°, vertikal 8°
- Wandmontageschrauben nicht im Lieferumfang enthalten

TV bracket HTV 14

- For screen sizes up to 43cm
- Maximum loading 30 kg
- Supporting surface 317 x 280mm
- Can be pivoted: 220° horizontally and 8° vertically
- Wall-mounting screws are not included in the scope of delivery

EAN	Art.-Nr. item-no.	Länge length	DIY	VPE QTY
40009530	2710 5	-	-	4



TV-Halter TV 40SW

- Für Bildschirmgrößen bis 41cm
- Maximale Belastbarkeit 40 kg
- Auflagefläche 350 x 260mm
- Schwenkbar: horizontal 360°, vertikal 8°
- Wandmontageschrauben nicht im Lieferumfang enthalten

TV bracket TV 40SW

- For screen sizes up to 41cm
- Maximum loading 40 kg
- Supporting surface 350 x 260mm
- Can be pivoted: 360° horizontally and 8° vertically
- Wall-mounting screws are not included in the scope of delivery

EAN	Art.-Nr. item-no.	Länge length	DIY	VPE QTY
40009530	2719 8	-	-	4

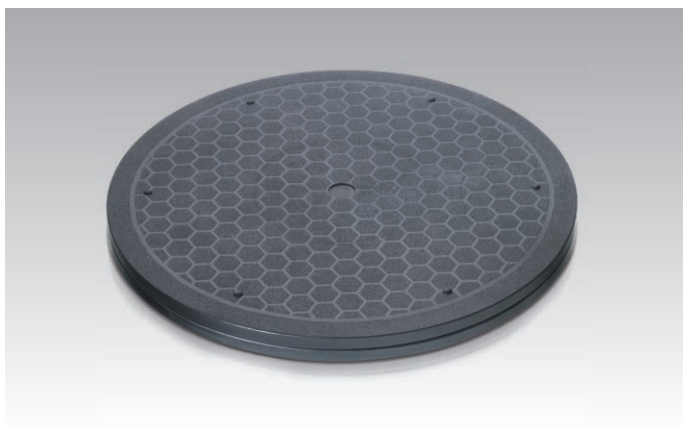

Universal-Drehteller

Für Fernseher, Monitore, Lautsprecher, Hifi-Geräte etc.

- Durchmesser 30cm
- Maximale Belastbarkeit 35 kg
- 21 mm Profil
- 360° drehbar • Leichtlaufrotation

Universal turntable

For TVs, monitors, speakers, hifi systems etc.

- Diameter 30cm
- Maximum load 35 kg
- 21 mm height
- Can be pivoted through 360° • Easy rotating action

EAN	Art.-Nr. item-no.	Ø	DIY	VPE QTY
40009530	2724 2	30cm	-	4



Lautsprecher Wandhalterung LS-5S

- Passend für kleine Home Cinema-Lautsprecher
- Maximale Belastbarkeit 5kg
- Position optimal einstellbar (180° drehbar und 15° neigbar)
- Einfache Montage
- Wandmontageschrauben nicht im Lieferumfang enthalten!

Loudspeaker wall mount

- Suitable for small home cinema loudspeakers
- Maximum loading 5 kg
- Optimally adjustable position (180° revolving and 15° can be tilted)
- Simple mounting
- Wall-mounting screws are not included in the scope of delivery!

EAN	Art.-Nr. item-no.	Länge length	DIY	VPE QTY
40009530	2702 0	-	-	4





Fashion In-Ear Kopfhörer mit 3,5 mm Klinkenanschluss

- 3,5 mm Klinkenstecker ideal für MP3 Player
- Formschönes Design mit Schmuckapplikation
- Extremer Tragekomfort durch Silikonaufsatz
- Frequenzbereich 20 Hz – 20 kHz

Um Hörschäden zu vermeiden, Ohrhörer nicht längere Zeit bei hoher Lautstärke benutzen.

Fashion In-Ear Headphones with 3.5 mm jack connection

- 3.5 mm jack plug ideal for MP3 players
- Stylish design with headphone charm
- Extremely comfortable due to silicone ear tips
- Frequency range 20 Hz – 20 kHz

To avoid damage to your hearing, do not use the headphones at an excessively high volume for longer periods.

EAN	Art.-Nr. item-no.	Länge length	DIY	VPE QTY
40009530	2318 3	1,2m	-	25



Stereo Kopfhörer-Set

- inkl. 2,5 mm Adapter und Ersatzzohrpolster
- Kabellänge: 1,2m
- Stecker: 3,5 mm
- Frequenz: 20-20.000 Hz
- Impedanz: 32 Ohm
- Empfindlichkeit: 100 dB

Um Hörschäden zu vermeiden Ohrhörer nicht längere Zeit bei hoher Lautstärke benutzen.

Stereo headphones set

- incl. 2.5 mm adapter and spare ear cushion
- Cable length: 1.2 m
- Jack: 3.5 mm
- Frequency: 20-20,000Hz
- Impedance: 32Ohm
- Sensitivity: 100dB

In order to avoid damage to hearing, do not use headphones at high volume for long periods.

EAN	Art.-Nr. item-no.	Länge length	DIY	VPE QTY
40009530	2398 5	1,2m	-	12



Headset für Schnurlostelefone

Für Gigaset Telefone (DECT) mit 2,5 mm Klinken-Buchse
Eine bequeme Erweiterung zum Freihandtelefonieren mit Mobilteilen von DECT-Schnurlostelefonen. Ideal für Büro und Hausarbeit. Flexibler Ohrclip für hohen Tragekomfort. Links und rechts tragbar. Individuell justierbarer Mikrofonarm. Hohe Gesprächsqualität.

Headset for cordless telephones

For Gigaset telephones (DECT) with 2.5 mm jack socket
A convenient add-on for hands-free telephoning with DECT cordless telephone handsets. Ideal for office and housework. Flexible ear-clip for good wearing-comfort. Can be worn on the left or right. Individually adjustable microphone arm. Excellent sound quality.

EAN	Art.-Nr. item-no.	Länge length	DIY	VPE QTY
40009530	7400 0	1,0m	-	6

AKKUS

BATTERY



NiMH Akku Micro/AAA 1,2V
bis zu 1.000x wiederauffadbar

NiMH battery Micro/AAA 1.2V
can be recharged up to 1.000 times

EAN	Art. -Nr. item-no.	Länge length	DIY	VPE QTY
40009530	7359 1	1000mAh	-	12
40009530	7360 7	800mAh	-	12



REINIGUNG

CLEANING



Home Office Reinigungsset

Monitor/TV/Tastatur Reinigungsset 3 in 1
Zur Reinigung von Monitoren, TV's und Tastaturen. Mit Antistatic-Effekt.

Vor Verwendung Netzstecker ziehen und das Spray aus ca. 10-15 cm aufsprühen. Danach mit dem Applikator reinigen. Spray darf nicht in die Hände von Kindern gelangen.
Inhalt: Spray, Applikator, Ersatzschwämme

Home Office Cleaning Set

3 in 1 monitor/TV/keyboard cleaning set
For monitors, TVs and keyboards. With antistatic effect.
Pull out the mains plug before use and spray from a distance of approx. 10-15 cm. The clean with the applicator. Keep away from children.
Contents: spray, applicator, spare sponges

EAN	Art. -Nr. item-no.	Länge length	DIY	VPE QTY
40009530	8789 5	-	-	6

SONSTIGES

OTHERS



ORF-Start-Set

Der Lieferumfang enthält:
ORF Smart Card, Irdeto CAM Modul, Anmeldeunterlagen

EAN	Art. -Nr. item-no.	Länge length	DIY	VPE QTY
4000953	39600 3	-	-	1

SM ELECTRONIC GmbH
Waldweg 2
22145 Stapelfeld/Braak

Telefon 040-67509-0
info@sm-electronic.de
www.sm-electronic.de
www.skymaster.de

SM ELECTRONIC GmbH ist ein Unternehmen der **GIGASET AG**.